



★ SINCE 1947 ★

DEKS

LANDSCAPING

BY DESIGN



✉ sales@deks.co.uk

🌐 www.deks.co.uk

☎ 01275 858 866



View our Landscaping product range on our website here.



To find your DEKS contact on a Map please connect to our website with this QR code.

SCOTLAND

Neil Cauldwell

BUSINESS DEVELOPMENT MANAGER
neilc@deks.co.uk
07494 230 768

NORTH ENGLAND & IRELAND

Martin Hipkin

BUSINESS & PRODUCT DEVELOPMENT DIRECTOR
martinh@deks.co.uk
07780 446 597

SOUTH WEST & WALES

Martin Hipkin

BUSINESS & PRODUCT DEVELOPMENT DIRECTOR
martinh@deks.co.uk
07780 446 597







SOUTH EAST & HOME COUNTIES

Andy Minas

SALES DIRECTOR
andym@deks.co.uk
07534 294 255



CONTENTS

	DekDrain VELA A15 - Domestic	5 - 7
	<ul style="list-style-type: none"> ▪ A15 Edge - Slot Drain ▪ A15 Linear Bar Wave ▪ A15 Vela Sump Kit & Accessories 	
	DekDrain Hydrus	8 - 9
	<ul style="list-style-type: none"> ▪ B125 Yard Gully ▪ Paving Plus ▪ Catch-Pit 	
	DekRock Heavy - Grass / Gravel Grids	10
	DekRock Gravel	11
	DekRock Garden Edging	12
	Pedestals - Tile & Decking	13 - 15
	Tile Spacers - X, T & Penta	16 - 19
	<ul style="list-style-type: none"> ▪ Two Level System ▪ Tiling Spacers & Accessories ▪ Speed Level Levelling System ▪ Outside Tile Levelling Plate 	

CLASS A15

15 kN load test = 1.5 tons
Group 1: Areas that can be used only by pedestrians and cyclists.

CLASS B125

125 kN load test = 12.5 tons
Group 2: Pedestrian paths, pedestrian areas and comparable areas, parking for private cars or multilevel car parks.

CLASS C250

250 kN load test = 25 tons
Group 3: Road curbs and areas not directly exposed to vehicle traffic or similar; elements of the curb are always included in Group 3.

CLASS D400

400 kN load test = 40 tons
Group 4: Roads with heavy traffic (including pedestrian streets), docks and parking areas for all types of road vehicles.

CLASS E600

600 kN load test = 60 tons
Group 5: Areas subjected to extremely heavy vehicle traffic, for example roads and docks in ports.

CLASS F900

900 kN load test = 90 tons
Group 6: Areas subjected to loads from large wheels, for example flooring in airports.



DOMESTIC DEKRAIN VELA

A15
BS EN 1433

- 85mm and 50mm depths, for all paving depths, including porcelain.
- 5 Options in grating types, choose your style.
- No Corner quads needed, saves £s on expensive fittings.
- Heel Guard Gratings, lowers the risk of personal injuries.
- BS EN1433, peace of mind quality product, it will take the load it says it will.

Striking Design Options in A15 Channel Drain

The complete system for your surface water drainage project. Vela now offers 5 Grating Options and two new channel depths, so that you can choose how you want the finished project to look.

- Stainless Steel Edge Brick Slot - Heel-Safe (PP/SS)
- Stylish Linear Bar Wave - Heel-Safe (PP)
- Mesh/Grid - Heel-Safe (PP)
- Wave Threshold - Heel-Safe (PP)
- Traditional Galv Steel Slotted Gratings



PP gratings, "stops water in its tracks," achieving the ultimate in water flow into the channel. Water is disrupted in its flow and will not traverse the channel.

Both channel sizes have the capability to be connected together easily at each end to form corners, tees and other more staggered configurations without the need for expensive fittings.

There is also a full range of accessories including a 4 screw bottom connector to 110mm underground pipes and end caps to seal at each end.

New to the Vela Range is a unique trapped Outlet that can be fitted where required, this prevents debris and foul smells from buried drains (Page 8).

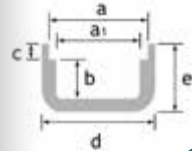

	a	a ₁	b	c	d	e	Length	∅ inf.
Standard Plastic and Galv	117	92	67	-	121	85	1.000	40/63/100mm
Shallow Plastic and Galv	117	92	32	-	121	50	1.00	40/63/100mm

84 & 50mm Channel
With 3 New Grating Options

No More
Corner quads, connecting ends, for corners, tee's and staggered drainage systems

NEW!
Inline Trapped Sump Gully & Leaf Guard

DekDrain A15 Edge - Slot Drain

**NOW with
Stainless
Steel Edge**

Why Choose DekDrain Edge?

Fantastic, new and improved Vela Edge Slot Drain comes on both a 84mm and 50mm depth channel with a new, much requested, 20mm up-stand for Porcelain paving. We listen to what you ask for, and we deliver DekDrain. No more deep excavations for drainage with this option, in 20mm up-stand and 50mm channel you have the lowest option metal Slot Drain there is on the market. And our traditional 87mm up-stand will cater for all other paving options we can think of.

Product Code	Dimensions	Description
DCD-VL84-SD87	121 x 84 x 1000mm	A15 Edge Slot Drain Upstand 87mm - 84mm Deep
DCD-VL50-SD87	121 x 50 x 1000mm	A15 Edge Slot Drain Upstand 87mm - 50mm Deep
DCD-VL84-SD20	121 x 84 x 1000mm	A15 Edge Slot Drain Upstand 20mm - 84mm Deep
DCD-VL50-SD20	121 x 50 x 1000mm	A15 Edge Slot Drain Upstand 20mm - 50mm Deep
DCD-VL-BO	110mm	Bottom Outlet with 4 Screws
DCD-VL84-EC	121 x 84mm	End Cap Pack of 2 - 84mm
DCD-VL50-EC	121 x 50mm	End Cap Pack of 2 - 50mm
DCD-VL-SDIH87	87mm	Access Point Including Plastic & Metal Grill
DCD-VL-SDIH20	20mm	Access Point Including Plastic & Metal Grill



DekDrain A15 Linear Bar Wave

A15 Linear Bar Wave Premier Class Surface Water Channel Drainage

Gratings designed, engineered and improved. The DekDrain Linear Bar Wave is super stylish with Heel Guard compliance, giving a 6-7mm gap and has added slip protection as standard. Gone are the corner quads as this new system is inter-connectable - we have you covered with right angle's, tee's, cross section's, or staggered options. No more expensive fittings.

Product Code	Dimensions	Description
DCD-VL84-LB	121 x 84 x 1000mm	A15 Linear Bar Wave HG Grate 1m - 84mm Deep
DCD-VL50-LB	121 x 50 x 1000mm	A15 Linear Bar Wave HG Grate 1m - 50mm Deep
DCD-VL-BO	110mm	Bottom Outlet with 4 Screws
DCD-VL84-EC	121 x 84mm	End Cap Pack of 2 - 84mm Deep
DCD-VL50-EC	121 x 50mm	End Cap Pack of 2 - 50mm Deep



Sump Kit A15 Vela

In-line Trapped Sump Outlet with Leaf Guard

Connects any 50mm/2" outlet to 100m/4" underground drainage pipe. The outlet connector is rotational in any direction as well as adjustable from 0-90 degrees.

Product Code	Dimensions	Description
DCD-VL-SK	110mm	Outlet Trapped Sump Gully with Leaf Guard

Sump; 84mm In-line trapped Sump/Gully with dip-tube trap and Leaf Guard. This inexpensive clever unit will replace the bottom outlet with a 110mm connection to below ground pipework. Seals to the

underside of the channel with a rubber seal and 4 screws, the dip tube trap is inserted from inside under the grating and Leaf Guard fitted all in one handy bag. Comes with 2 x 84mm end caps.

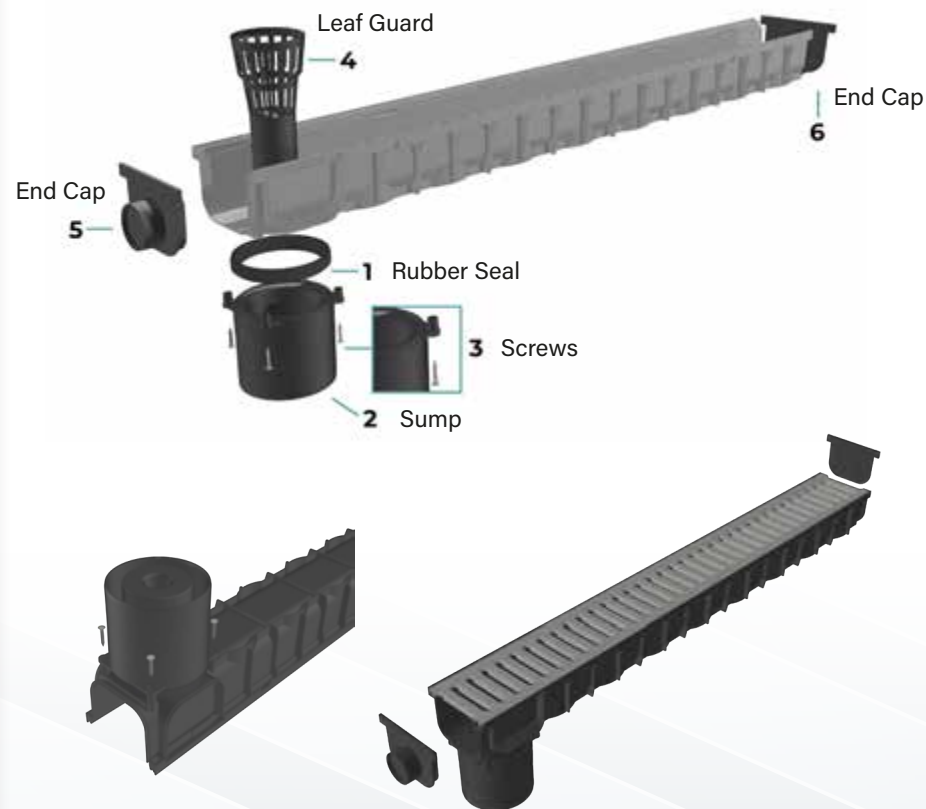

DekDrain Hydrus B125 Yard Gully

300 x 300mm Trapped Yard Gully, Catch-Pit with B125 Cast Iron Grating

- The yard gully is already provided with; - B125 Cast Iron grating - Black Bell Trap with a practical handle for quick and easy removal and cleaning.
- All in one gully so no need to buy expensive silt bucket and grating separately.
- Pipes of varying sizes can easily fit thanks to the special pre-cut concentric shaped holes on the sides.
- Load resistant, thanks to the reinforcements and ribs on the sides.
- Made of PP (polypropylene) and ductile-iron (grating).
- Connects up to 3 drainage runs with variable connections on each side face and discharges water through 1 outlet with the same options in pipe size.
- It is used as an alternative to a traditional concrete yard gully for the collection of surface water.
- Can be used to increase diameter, takes pipes of varying diameters, turn corners and still provides easy access for cleaning.
- Can be used in conjunction with a raiser and solid covers for areas where no surface drainage is required.

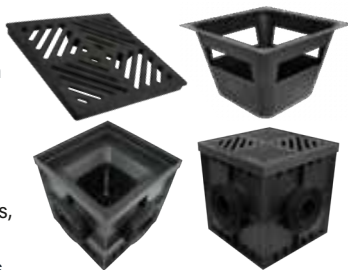

SEE OUR CATCH-PIT RANGE:

Product Code	Dimensions	Description
DCD-HY300/300-BB	300 x 300 x 300mm	Black Yard Gully / Catch-Pit with Trap and Cast Iron Grill Ø 75-140

Polypropylene Paving Plus

Black Grating for Channel with Central Slot Shape

The plate of the grating is recessed, so paving can be bedded on infill mortar. Paving can be cut to size to the external surface around the grating to guarantee a perfect aesthetic result. The grating can be lifted for flushing/cleaning and is made of PP (polypropylene). Used in pedestrian areas. Its slot shape guarantees a perfect integration with the ground and suggested use is in domestic environments.

- The dimensions are 130 x 500 x h 20mm
- The central slot grating is available in different heights: 0mm, 20mm, 40mm



Product Code	Dimensions	Description
DCD-HY137/84-B19B	130 x 75 x 1000 int	Black 110mm Bottom Outlet - Central Slotted Grille - 0mm Up-stand
DCD-HY137/84-B20B	130 x 75 x 1000 int	Black 110mm Bottom Outlet - Central Slotted Grille - 20mm Up-stand
DCD-HY137/84-B21B	130 x 75 x 1000 int	Black 110mm Bottom Outlet - Central Slotted Grille - 40mm Up-stand

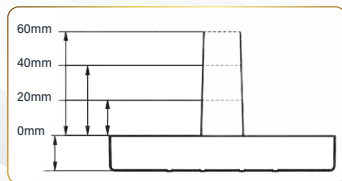

DekDrain Hydrus Catch Pit

Standard Catch Pit

- Made of PP (polypropylene).
- It is used as an alternative to a traditional concrete catch pit.
- Light weight for easy transport, positioning and installation, even by a single person.
- High resistance, thanks to the reinforcements and ribs on the sides.
- Pipes of every size can easily fit thanks to the special pre-cut concentric shaped holes on the sides.
- Compatible with relative PP Catch Pit cover.

DekDrain Catch Pits

Product Code	Dimensions	Description
DCD-CP300/300-GRY	300 x 300mm	DekDrain - Catch Pit - PP GREY Ø 75-140
DCD-CP300/300-GRN	300 x 300mm	DekDrain - Catch Pit - PP GREEN Ø 75-140

DekDrain Catch Pit Riser & Siphon Plates

Product Code	Dimensions	Description
DCD-CP300/300-R100	300 x 300mm	DekDrain - Catch Pit - PP GREY 100mm Riser
DCD-CP300/300-SP	300 x 300mm	DekDrain - Catch Pit Siphon Plates - PP GREY

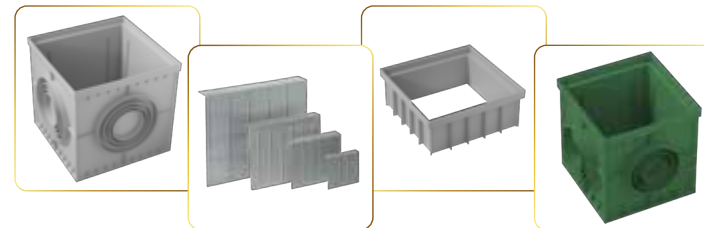

DekDrain Catch Pit Covers / Gratings with Handle

Product Code	Dimensions	Description
DCD-CP300/300-COV-GRY	300 x 300mm	DekDrain - Catch Pit Cover - PP GREY - Solid Cover with Handle
DCD-CP300/300-COV-GRN	300 x 300mm	DekDrain - Catch Pit Cover - PP GREEN - Solid Cover with Handle
DCD-CP300/300-GRT-GRY	300 x 300mm	DekDrain - Catch Pit Cover - PP GREY - Grating with Handle
DCD-CP300/300-GRT-GRN	300 x 300mm	DekDrain - Catch Pit Cover - PP GREEN - Grating with Handle

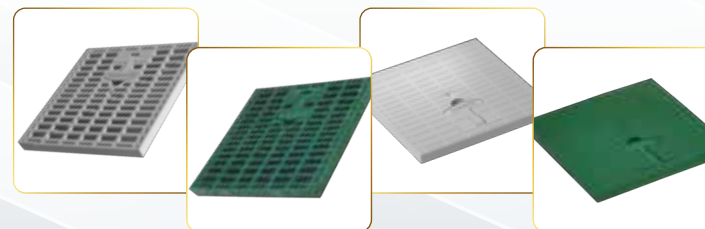

DekRock Heavy

Permeable and landscaping ground stabilisation - Drives, Patios, Gardens, Events, Drives, Parks & Leisure Areas. A big advantage is the application for overspill car parks.

SPECIFICATIONS

Product Code - DCD-DRPG-B (Black)	
Product Code - DCD-DRPG-G (Green)	
Length	493mm
Width	493mm
Height	39mm
Weight	5kg/m ²
Coverage	4 Tiles/m ²
Material	Recyclable PP (polypropylene)
Connection	Tongue and Groove
Colour	Black or Green
Finish	Grass or Gravel

KEY FACTS

- 35 tonne axle load capability
- Creates a dynamic surface that will not crack pothole & self-destruct
- Solves problematic drainage issues through permeability
- Onsite SuDS compliant
- Durable, strong and long lasting
- Strong interlocking design fast installation time
- DekRock reduces the carbon footprint of a project, and it is completely recyclable
- A big benefit is the reduction in pavement installation time versus traditional paving installation methods
- Preservation of natural (grass) aesthetics.

High Strength
Built in locking tongue and groove joints clicked together, offers stability when installed.

Permeable Design
SuDS compliant - offers excellent water permeation through the surface avoiding ponding areas.

Load Capacity
910+ tonnes/m² on a correctly specified and compacted sub-base-ISO844 certified.

Quality Design
Strong locking connections for seamless joints do not detach or separate.

Application Options
Both gravel or grass filled keeps ground stabilised and looking great, with low-maintenance for future on costs.

Improved Environment
Aesthetically beneficial and practical containment of the landscape, cleaner surrounding areas.

Stable
Made of recycled PP (polypropylene) and fully recyclable.

- DekRock
- Compacted Screeding/ Concreting Sand 50mm
- Geotextile Layer
- Compacted Stone (MOT Type 1)
- BiAxial Geogrid (optional)
- Compacted Soil/ Earth

Technical Data

Grid-fill Mediums	NBS Sec Q23	Angular Gravel up to 20mm
-	NBS Sec Q30	Grass Seeding/ Turfing
Sub-Base Requirements	-	Inert Stabilised Material
Max Gradient	-	12%
Max Vehicle Speed	-	15
Max Carry Load	ISO844	35 Tonne Axle Load
Estimated Rate of Installation	M ² / Hr / Person	220
Colours	-	Black & Green
Void Ratio	% Open	99.2

DekRock Gravel

Permeable Ground Stabilisation, Pathways, Drives, Patios, Gardens, Events, Parks & Leisure Areas.

KEY FACTS

- 20 tonne axle weight
- For areas where containment is the key, permanent non migrating features, creative designs and options too
- SuDS compliant, filtered draining lose the mud not the gravel
- NBS Specification support in accordance with Q23 for gravel surfacing or Q30 for seeding/turfing
- Durable, Lightweight .95 Mtr² square unit delivers faster install time
- Affixed Geotextile Backing reduces extra costs and laying time
- The lightweight interlocking design stops separation and creates a seamless professional finish
- Recyclability improves carbon footprint
- No need to buy and install a geotextile separately reduces waste and overlaps will not lift move or blow away during installation

SPECIFICATIONS

Product Code - DCD-DRSG-W (White)	
Length	1123mm
Width	795mm
Height	30mm
Weight	4.14kg/m ² - 9.13lbs/m ²
Coverage	0.95m ²
Material	100% Recyclable Plastic
Connection	M/F Peg
Colour	White
Finish	Grass or Gravel

Permeable Design
Excellent water permeation through the surface avoiding ponding and muddy areas.

Environmentally Friendly
100% recycled plastic and no need to constantly replace lost surface structure.

Load Capacity
140-400 Tonnes/m² (See table) on a correctly specified and compacted sub-base-ISO844 certified.

Cleaner Accesses
Premature deterioration causes maintenance costs, create better clean zones using DekRock Gravel saves you money.

Quality Design
Our geotextile backed open cell pockets, give stability when installed preventing movement and failures.

Each grid is connected by way of a male/female peg joint that are simply pushed together.

Technical Data

Void Ratio	% Open	99.4
Load Bearing Capacity	Empty	140 Tonnes/M ² (EN ISO 844)
-	Filled	400 Tonnes/M ² (EN ISO 844)
Operating Temperature	°C	-50 to +80
Chemical Resistance	-	Resistant to Acid, Leaching, Alcohol, Oil, Petrol, Strewing Salts, Ammonia etc.
Grid-fill Mediums	NBS Sec Q23	Angular Gravel up to 10mm
-	NBS Sec Q23	Grass Seeding/ Turfing
Sub-Base Requirements	-	Inert Stabilised Material
Max Gradient	-	10%
Max Vehicle Speed	-	10
Max Carry Speed	-	20 Tonne Axle Load
Estimated Rate of Installation	M ² / Hr / Person	300
Colours	-	White

DekRock Garden Edging

Garden border edging product for outdoor use that allows you to define and model lines and create curves between different external areas.

The profiles are very easy to install and disassemble and withstand variable weather conditions and physical tractions. The installation is quick and easy and it does not require any particular or specific tool.

The profiles are connected to each other thanks to their joint shape, then they are positioned according to the preferred layout and fixed to the ground using the provided plastic spikes. It is an excellent alternative to heavier and less aesthetically pleasing concrete edges.



Can be used as a paving edge restraint.



Product Code	Description	Height	Length
DCD-GES-45	DEKDrain - Garden Edge Strip	45mm	3m x 12 Spikes
DCD-GES-60	DEKDrain - Garden Edge Strip	60mm	3m x 12 Spikes

Effective length of the package kit of garden border edging: 3 metre, complete with 12 plastic spikes. It is available in two different heights: 45mm and 60mm, both in black and made of PP (polypropylene).

Pedestals - Tile & Decking

ARKIMEDE LINE The most innovative support, with a complete line of accessories that enable you to reach different heights to optimise your installation.

The supports for raised floors have been designed to support high load, combining versatility, sound insulation, ease of installation and adjustment, even when the floor has already been laid.

PRODUCED WITH RECYCLED AND RECYCLABLE MATERIAL These products have been made using self-produced photovoltaic energy and using recycled raw materials, both from the regeneration of waste plastic materials in production, and by using post-consumer recycled polymers.



ARKIMEDE 10 PAVING

Product Code	Height	Description
PED-A10-PV2	From 10 to 20mm	DEKS Pedestal PP - Paving 2mm Spacer
PED-A10-PV4	From 10 to 20mm	DEKS Pedestal PP - Paving 4mm Spacer



ARKIMEDE 18 PAVING

Product Code	Height	Description
PED-A18-PV2	From 18 to 36mm	DEKS Pedestal PP - Paving 2mm Spacer
PED-A18-PV4	From 18 to 36mm	DEKS Pedestal PP - Paving 4mm Spacer



ARKIMEDE 35 PAVING - The extensions make it possible to achieve heights of up to 1m

Product Code	Height	Description
PED-A35-PV2	From 35 to 60mm	DEKS Pedestal PP - Paving 2mm Spacer
PED-A35-PV4	From 35 to 60mm	DEKS Pedestal PP - Paving 4mm Spacer



ARKIMEDE 60 PAVING

Product Code	Height	Description
PED-A60-PV2	From 60 to 115mm	DEKS Pedestal PP - Paving 2mm Spacer
PED-A60-PV4	From 60 to 115mm	DEKS Pedestal PP - Paving 4mm Spacer



ARKIMEDE 115 PAVING

Product Code	Height	Description
PED-A115-PV2	From 115 to 220mm	DEKS Pedestal PP - Paving 2mm Spacer
PED-A115-PV4	From 115 to 220mm	DEKS Pedestal PP - Paving 4mm Spacer



ARKIMEDE EXTENSIONS

Product Code	Height	Description
PED-EX25	25mm	Extension
PED-EX50	50mm	Extension
PED-EX100	100mm	Extension



Pedestals - Tile & Decking

Introducing the DEKS Arkimede family of adjustable supports that allow the laying of raised floors or decking from 10mm to 1m using the extensions.

ARKIMEDE PAVING, SELF-LEVELLING HEAD

Product Code	Dimensions	Description
PED-SLH2	2mm Joint	Self Levelling Head - 4 Wings
PED-SLH4	4mm Joint	Self Levelling Head - 4 Wings



Arkimede Self Levelling is an accessory that connects with the Arkimede support. It can be matched with all of the Arkimede Paving Line. The installation on the head of the support can be made once the wings are removed. The installation of the Self Levelling Head increases the total height of the support of 14mm. It guarantees a levelling on 0% to 5% slopes. Made of Polypropylene and used for external areas.

CLEVER SLOPE REGULATOR

Product Code	Slope %	Description
PED-CS1	1%	Arkimede Clever Slope Regulator
PED-CS3	3%	Arkimede Clever Slope Regulator
PED-CS5	5%	Arkimede Clever Slope Regulator

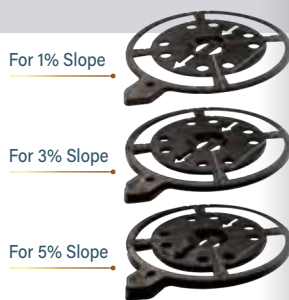

Levelling Rubber Disc for sloping compensation with a diameter of 120mm, available in three different models of, 1%, 3%, 5% size slopes. Made of thermoplastic rubber. Position on the head of the support (with the arrow facing the direction of the slope) and twist it for a final regulation. Clever, guarantees to have a perfectly flat surface, and to reduce any walkover noise.

ARKIMEDE INSULATION NOISE REDUCER

Product Code	Dimensions (mm)	Description
PED-INR	200 x 200, 3mm Thick	Arkimede Insulation Noise Reducer



Sound Absorbing Rubber Mat for the Arkimede range telescopic support, with a thickness of 3mm. Made of rubber (TPV). The product is positioned at the base of the Arkimede range telescopic support to reduce footfall noise up to 12 dB.

ARKIMEDE PLASTIC LATERAL FINISHING KIT

Product Code	Dimensions	Description
PED-LFP	204 x 204mm	Lateral Finishing Plate - 10 Pieces, 30 Lugs

Kit Component Parts

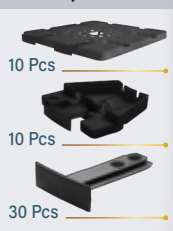

Plate and Lateral Clip are made of polypropylene, they are used for the lateral finishing of the perimeter space in the absence of a lateral wall, in the installation of raised floors. Specifically designed for application with the Arkimede supports only. The adjustable clips allow the fixing of tiles of different thicknesses, from 8 to 38mm, in a very easy and simple way.

Plate and lateral clip fit with head for tile (2 or 4mm) and work with Arkimede 35, 41, 60 and 115 paving only.



Arkimede 35, 41, 60 and 115 paving only.



Adjustable Clips from 8 to 38mm.



Accessory - Rubber Shim.

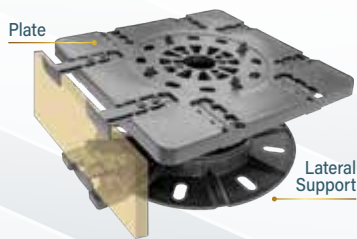

Lateral Support

Pedestals - Tile & Decking

UNIVERSAL CLIP FOR LATERAL LAYING

Product Code	Material	Description
PED-UCLL	Stainless Steel	Universal Clip for Lateral Laying
PED-UPSB	-	Universal Perimeter Support Brackets
PED-UPSB-PP	-	PP Perimeter Support Brackets



Installation Guide

Universal Clip for the perimeter laying of tiles for floating floors. The clip eliminates contact between the tiles and wall thanks to its special shape that absorbs possible movement and expansion. Specifically designed to be used with these Arkimede, 3D-Scopic, Hercules, and Level Up. Made of stainless steel or Polypropylene and used for the laying of perimeter tiles with floor supports.

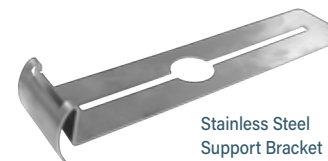

Stainless Steel Support Bracket

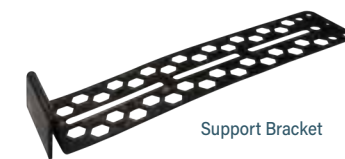

Support Bracket

DEKS Decking Line

Image	Product Code	Dimensions	Description
	PED-A10-DK	From 10 - 20mm	DEKS Pedestal PP - Decking
	PED-A18-DK	From 18 - 36mm	DEKS Pedestal PP - Decking
	PED-A35-DK	From 35 - 60mm	DEKS Pedestal PP - Decking
	PED-A60-DK	From 60 - 115mm	DEKS Pedestal PP - Decking
	PED-A115-DK	From 115 - 220mm	DEKS Pedestal PP - Decking



10 - 20mm

18 - 36mm

35 - 60mm

60 - 115mm

115 - 220mm

1

2

3

4

5

Tiling Spacers & Accessories

LEVELLING SYSTEMS AND SPACERS FOR TILES

For a perfect laying of the tiles on the floor and/or on the wall, there are various products that can help create the perfect installation. DEKS has a wide range of levellers and spacers in various shapes, sizes and colours, in order to meet every installers needs.

Two Level system Consists of two elements (1 spacer clip and a wedge), assembled and adjusted using pliers. Lippage will be eliminated whilst maintaining a perfectly flat surface. Spacers clips are available in sizes for: 0.5, 1, 1.5, 2, 3, 4, 5mm joints.

Speed Level Composed of two elements (cylinder and spacer screw) that rectify, in a simple and fast way, any irregularity between tile and tile during installation, thus obtaining a perfect installation. The cylinder is equipped with an anti-scratch disk for a safe installation, preventing any scratches on the surface in case of excessive screwing. Spacer screws are available in sizes for: 1, 1.5, 2, 3, 4mm joints.

Two Level - Single Elements Made from recycled plastic material

A levelling system and spacer for floor and wall tiles of various sizes and thicknesses.

Product Code	Joint Width	Tile Thickness/ Height	Description
PAV-LW-W	-	-	Levelling Wedge - 100pcs
PAV-LW-BP	-	-	Blue Plier for Levelling Wedge - 70pcs
PAV-LW-SC12-1	1mm	from 3mm to 12mm	Spacer Clip for Tiles - 250pcs
PAV-LW-SC12-1.5	1.5mm	from 3mm to 12mm	Spacer Clip for Tiles - 250pcs
PAV-LW-SC12-2	2mm	from 3mm to 12mm	Spacer Clip for Tiles - 250pcs
PAV-LW-SC12-2.5	2.5mm	from 3mm to 12mm	Spacer Clip for Tiles - 250pcs
PAV-LW-SC12-3	3mm	from 3mm to 12mm	Spacer Clip for Tiles - 250pcs
PAV-LW-SC12-4	4mm	from 4mm to 12mm	Spacer Clip for Tiles - 250pcs
PAV-LW-SC12-5	5mm	from 5mm to 12mm	Spacer Clip for Tiles - 250pcs
PAV-LW-SC20-1	1mm	from 12mm to 20mm	Tall Spacer Clip for Tiles - 50pcs
PAV-LW-SC20-2	2mm	from 12mm to 20mm	Tall Spacer Clip for Tiles - 50pcs
PAV-LW-SC20-3	3mm	from 12mm to 20mm	Tall Spacer Clip for Tiles - 50pcs
PAV-LW-SC20-5	5mm	from 12mm to 20mm	Tall Spacer Clip for Tiles - 50pcs
PAV-LW-SC12-1/500	1mm	from 3mm to 12mm	Spacer Clip for Tiles - 500pcs per bag
PAV-LW-SC12-2/500	2mm	from 3mm to 12mm	Spacer Clip for Tiles - 500pcs per bag
PAV-LW-SC12-3/500	3mm	from 3mm to 12mm	Spacer Clip for Tiles - 500pcs per bag

Wedge

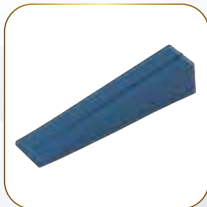

Spacer Clip



Tall Spacer Clip



Pliers



Tiling Spacers & Accessories

Two Level Kit

Product Code	Dimensions	Description
PAV-LW-LWK1	1mm	Two Level Kit: 100 Spacer Clips, 100 Wedges, 1 Plier - 1 Box
PAV-LW-LWK1.5	1.5mm	Two Level Kit: 100 Spacer Clips, 100 Wedges, 1 Plier - 1 Box
PAV-LW-LWK2	2mm	Two Level Kit: 100 Spacer Clips, 100 Wedges, 1 Plier - 1 Box
PAV-LW-LWK3	3mm	Two Level Kit: 100 Spacer Clips, 100 Wedges, 1 Plier - 1 Box
PAV-LW-LWK4	4mm	Two Level Kit: 100 Spacer Clips, 100 Wedges, 1 Plier - 1 Box
PAV-LW-LWK5	5mm	Two Level Kit: 100 Spacer Clips, 100 Wedges, 1 Plier - 1 Box

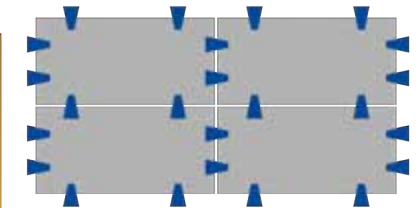
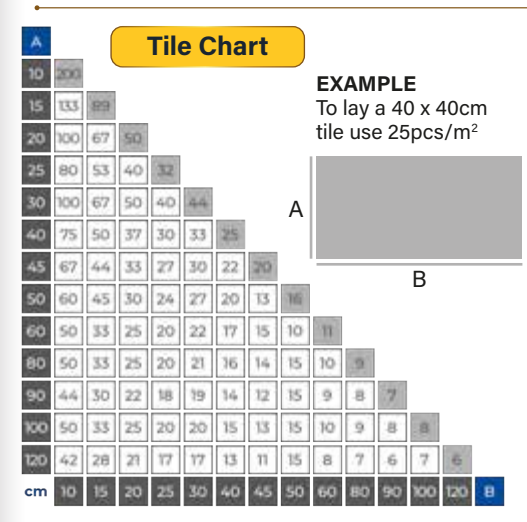

To watch Video

PENTA SPACER

Product Code	Dimensions (mm)	Description
PAV-PMS-BAG	0.5 / 1 / 1.5 / 2 / 3	Penta Multi Spacer 200pcs per bag
PAV-PMS-BOX	0.5 / 1 / 1.5 / 2 / 3	Penta Multi Spacer 600pcs per box



Reusable Multi-thickness Grout Spacer for Tiles With the use of this product it is possible to lay tiles with a grout line of 0.5, 1, 1.5, 2, 3mm, for floor and facade tiles.

Penta is:

- A new generation of Tile Spacer studied according to the UNI 11493-1 Standard - methodology for the correct installation of ceramic tiles.
- Designed to guarantee uniform grout lines between 0.5 - 3mm.
- Marked to be clearly visible, so that the 5 sides of the product correspond with different thicknesses.
- Designed so that it can be used on both floor and wall.
- Packed in boxes of 600 pieces and/or in bags of 200 pieces. (20 bags/box).
- Made of recycled plastic material.



Speed Level System

A system of two elements (cylinder with pre-mounted scratch proof disk and spacer screw). Once assembled and adjusted will ensure a uniform flat surface in the same plane.

Linear Spacer Screws are available for 1, 1.5, 2, 2.5, 3, 4mm grout joints. Cross and T Spacer Screws are available for 1, 2, 3mm grout joints.

Made of recycled plastic material and used as a levelling system and spacer for floor and wall tiles of various sizes and thicknesses.

Product Code	Joint Width	Tile Thickness/Height	Description
PAV-SL-C	-	-	Speed Level Cylinder - 50pcs
PAV-SL-LS1	1mm	From 3 to 22mm	Linear Spacer Screw - 100pcs
PAV-SL-LS1.5	1.5mm	From 3 to 22mm	Linear Spacer Screw - 100pcs
PAV-SL-LS2	2mm	From 3 to 22mm	Linear Spacer Screw - 100pcs
PAV-SL-LS2.5	2.5mm	From 3 to 22mm	Linear Spacer Screw - 100pcs
PAV-SL-LS3	3mm	From 3 to 22mm	Linear Spacer Screw - 100pcs
PAV-SL-LS4	4mm	From 3 to 22mm	Linear Spacer Screw - 100pcs
PAV-SL-CS1	1mm	From 3 to 22mm	Cross Spacer Screw - 100pcs
PAV-SL-CS2	2mm	From 3 to 22mm	Cross Spacer Screw - 100pcs
PAV-SL-CS3	3mm	From 3 to 22mm	Cross Spacer Screw - 100pcs
PAV-SL-TS1	1mm	From 3 to 22mm	'T' Shaped Spacer Screw - 100pcs
PAV-SL-TS2	2mm	From 3 to 22mm	'T' Shaped Spacer Screw - 100pcs
PAV-SL-TS3	3mm	From 3 to 22mm	'T' Shaped Spacer Screw - 100pcs

Speed Level Cylinder Linear Spacer Screw Cross Spacer Screw 'T' Shaped Spacer Screw



Speed Level Kit

Product Code	Dimensions	Description
PAV-SL-QK1	1mm	Speed Level Kit: 100 Disposable Linear Screws, 50 Levelling Cylinders
PAV-SL-QK2	2mm	Speed Level Kit: 100 Disposable Linear Screws, 50 Levelling Cylinders
PAV-SL-QK3	3mm	Speed Level Kit: 100 Disposable Linear Screws, 50 Levelling Cylinders
PAV-SL-QK4	4mm	Speed Level Kit: 100 Disposable Linear Screws, 50 Levelling Cylinders

NB: Refer to Tile Chart on page 17

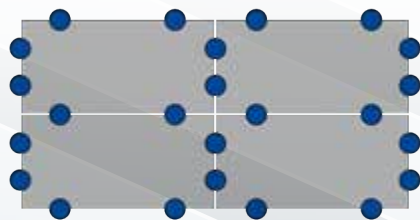

scan me



To watch Video

X and T Shaped Spacers for Tiles

	Product Code	Dimensions	Description
①	PAV-XSS-1	1mm	X Shaped Spacer - 200pcs
②	PAV-XSS-1.5	1.5mm	X Shaped Spacer - 200pcs
③	PAV-XSS-2	2mm	X Shaped Spacer - 200pcs
④	PAV-XSS-3	3mm	X Shaped Spacer - 200pcs
⑤	PAV-XSS-5	5mm	X Shaped Spacer - 200pcs
⑥	PAV-TSS-2	2mm	T Shaped Spacer - 200pcs

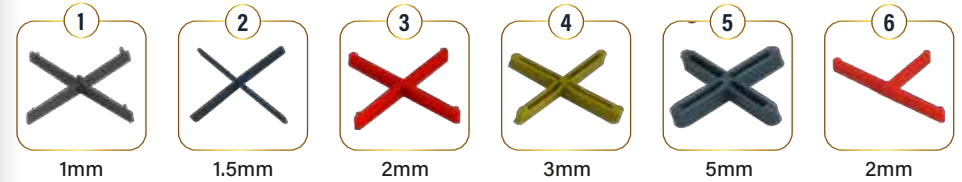

Plastic Levelling Tile for the laying of external paving tiles on unstabilised ground.

The plate allows the tiles to be fixed and levelled with DEKS Level, in order to avoid any lippage. The plate is for this purpose provided with 4 slots to use the linear levelling screws on each side and a cross-shaped slot, in the centre, to apply the Cross levelling screw.

In addition, the plate is provided with spacers tabs of 4 and 3mm to get uniform joints. The plate can be broken up into 2 pieces in order to be installed in the corners or near the wall on the perimeter.

With this set, outdoor paving can be installed on unstabilised gravel sub-floors, avoiding slippage, and without any unevenness.

Made of 100% recycled PP (polypropylene).

Installation Visual Aids

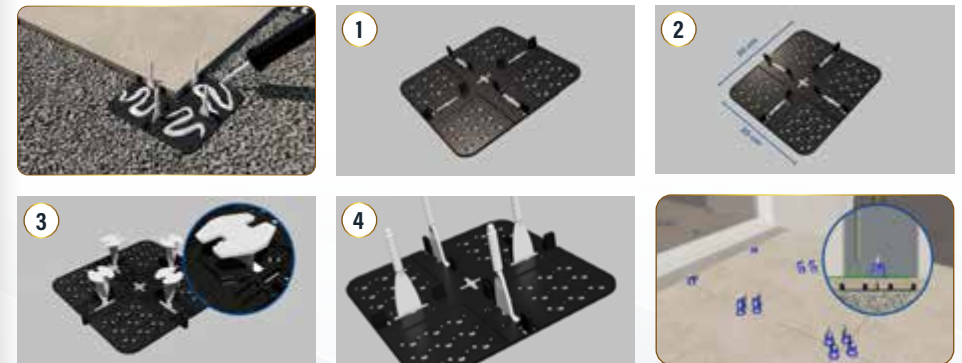

Product Code	Dimensions/Thickness	Description
PAV-PLP	200 x 200mm	Outdoor Paving Levelling Plate - Black - 10pcs
PAV-PLPK	10 x 20-30mm Tile Thickness	KIT: 10 Levelling Plates, 40 Lite Level Cylinders, 40 Linear Screws



 sales@deks.co.uk

 www.deks.co.uk

 01275 858 866



DEKS Industries Europe Ltd
West End Trading Estate
Blackfriars Road
Nailsea, Bristol, BS48 4DJ

DEKS takes reasonable care when compiling product information for use within marketing and technical documents. Any guidance and suggestions regarding the use of products is provided without guarantees, as conditions relating to the use and installation of products and systems are beyond our control. Customers are responsible for ensuring the suitability of the products and systems in their project.

The information within this brochure is believed to be correct at the time of printing. DEKS accepts no liability regarding the full accuracy and completeness of the information in its marketing and technical documents and no responsibility is accepted for printing errors. All descriptions of goods in marketing and technical documents are merely indicative of the nature of the goods. We reserve the right to alter the appearance or functionality of the materials or components of products at any time.