

# Thermawall® TW50

Partial fill cavity wall insulation

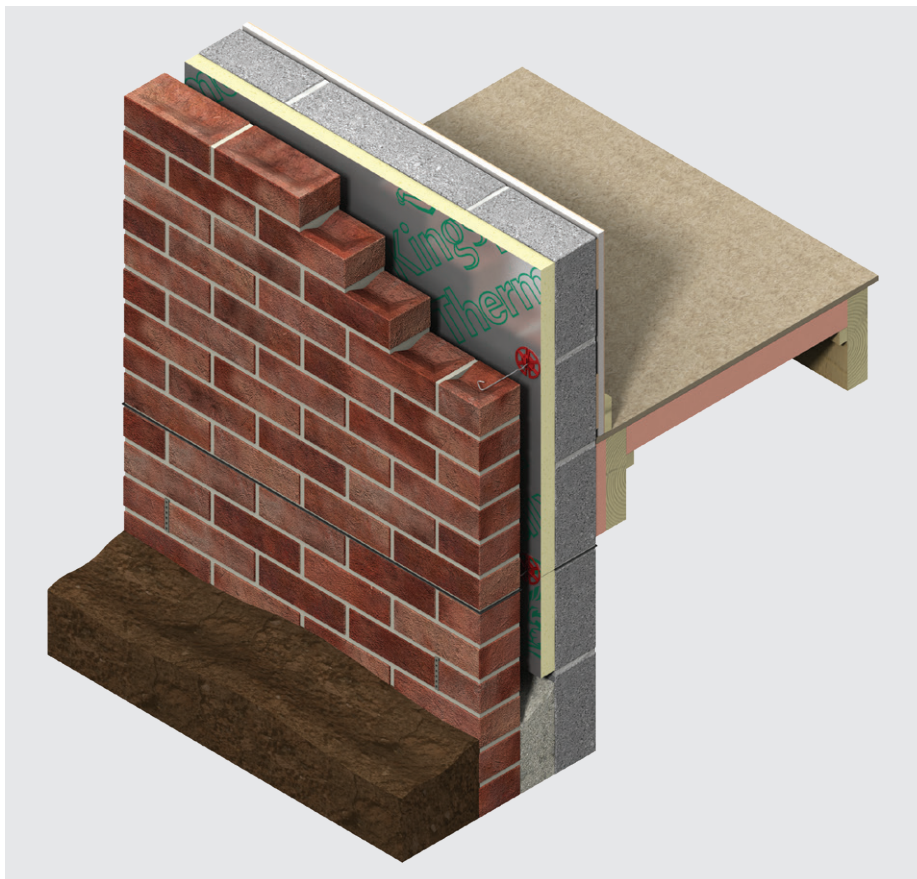

- High performance rigid thermoset insulation - thermal conductivity 0.022 W/mK
- Clear cavity is maintained - resists moisture penetration
- Low emissivity foil facings significantly increase the thermal resistance of the cavity
- Meets NHBC technical requirements when used with a 50 mm residual cavity
- Unaffected by air infiltration
- Easy to handle and install
- Non-deleterious material
- Manufactured with a blowing agent that has zero ODP and low GWP

# Typical constructions and U-values

## Assumptions

The U-values in the tables that follow have been calculated using the method detailed in BS EN ISO 6946: 2017 (Building components and building elements. Thermal resistance and thermal transmittance. Calculation methods), and using the conventions set out in BR 443 (Conventions for U-value calculations). They are valid for the constructions shown in the details immediately each table.

Unless stated otherwise the internal wall finish is taken to be a 3 mm skim coated 12.5 mm plasterboard on dabs.

These U-values are valid for constructions with both a 40 mm and 50 mm clear residual cavity between the outer surface of the insulation and the inner face of the outer masonry leaf.

NB When calculating U-values to BS EN ISO 6946: 2017 the type of wall tie used may change the thickness of insulation required. For cavity widths  $\leq 125$  mm, calculations assume a stainless steel flexible tie with 2.5 ties per  $m^2$  and a cross-sectional area of  $12.50 \text{ mm}^2$ . For cavity widths  $> 125$  mm, calculations assume a stainless steel flexible tie with 2.5 ties per  $m^2$  and a cross-sectional area of  $23.40 \text{ mm}^2$ . For cavity widths  $> 175$  mm, calculations assume a stainless steel flexible tie with 2.5 ties per  $m^2$  and a cross-sectional area of  $80.00 \text{ mm}^2$ .

NB For the purposes of these calculations the standard of workmanship has been assumed good, and therefore the correction factor for air gaps has been ignored.

NB The figures quoted are for guidance only. A detailed U-value calculation and a condensation risk analysis should be completed for each project.

NB If your construction is different from those specified, and / or to gain a comprehensive U-value calculation along with a condensation risk analysis of your project, please consult the Kingspan Insulation Technical Service Department for assistance (see rear cover).

NB There are potential restrictions placed upon this product which vary dependant on building type, height, construction and location in Great Britain. For guidance regarding the routes to compliance for meeting the fire safety requirements of the Building Regulations / Standards in Great Britain, refer to the relevant links to Government websites at [www.kingspaninsulation.co.uk/fireregulations](http://www.kingspaninsulation.co.uk/fireregulations).

## U-value table key

Further information on the applicable notional and area weighted average limiting U-values is available in the relevant geographical documentation:

- Approved Documents L to the Building Regulations for England;
- Approved Documents L to the Building Regulations for Wales;
- Technical Handbooks Section 6 to the Building Standards for Scotland; and
- Technical Booklets F1 & F2 to the Building Regulations for Northern Ireland.

## 10 mm polymer rendered 100 mm dense block outer leaf\* / 100 mm block inner leaf

Internal finish - fair faced blockwork

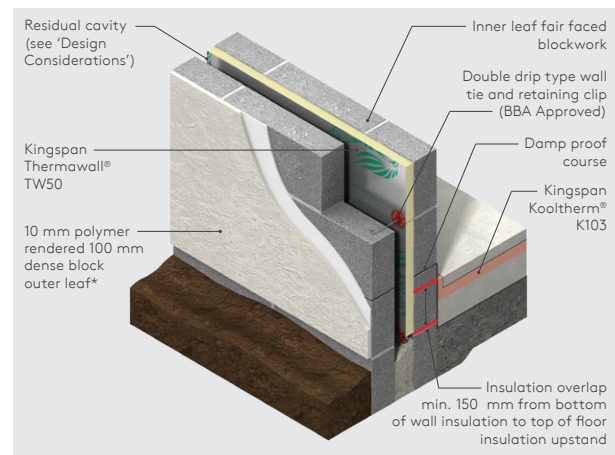

Figure 1

U-values ( $W/m^2K$ ) for various thicknesses of Kingspan Thermawall® TW50				
Insulant thickness (mm)	Inner leaf fair faced blockwork density and $\lambda$ -value ( $W/mK$ )			
	Dense (1.13)	Medium (0.51)	Lightweight (0.15)**	Aerated (0.11)**
40	0.35	0.34	0.29	0.28
50	0.30	0.29	0.26	0.25
60	0.26	0.25	0.23	0.22
70	0.23	0.23	0.21	0.20
75	0.22	0.22	0.20	0.19
80	0.21	0.21	0.19	0.19
100	0.18	0.17	0.16	0.16

\* Calculations assume dense block outer leaf of  $\lambda$ -value ( $1.13 \text{ W/mK}$ ).

\*\* A 6.6% thermal bridging factor has been assumed for the effect of mortar joints.

NB Some values may have been omitted from the table because they do not meet the most common minimum requirements.

NB Refer to local distributor or Kingspan Insulation price list for current stock and non-stock sizes.

# Typical constructions and U-values

Internal finish - 3 mm skim coated 12.5 mm plasterboard

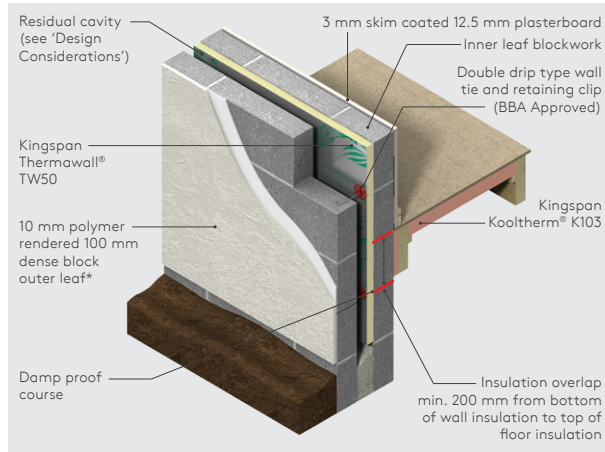

Figure 2

U-values (W/m <sup>2</sup> K) for various thicknesses of Kingspan Thermawall® TW50				
Insulant thickness (mm)	Inner leaf blockwork density and λ-value (W/mK)			
	Dense (1.13)	Medium (0.51)	Lightweight (0.15)**	Aerated (0.11)**
40	0.33	0.32	0.28	0.27
50	0.28	0.27	0.25	0.24
60	0.25	0.24	0.22	0.21
70	0.22	0.22	0.20	0.19
75	0.21	0.21	0.19	0.19
80	0.20	0.20	0.18	0.18
100	0.17	0.17	0.16	0.15

\* Calculations assume dense block outer leaf of λ-value (1.13 W/mK).

\*\* A 6.6% thermal bridging factor has been assumed for the effect of mortar joints.

NB Some values may have been omitted from the table because they do not meet the most common minimum requirements.

NB Refer to local distributor or Kingspan Insulation price list for current stock and non-stock sizes.

Internal finish - Kingspan Kooltherm® K118 Insulated Plasterboard

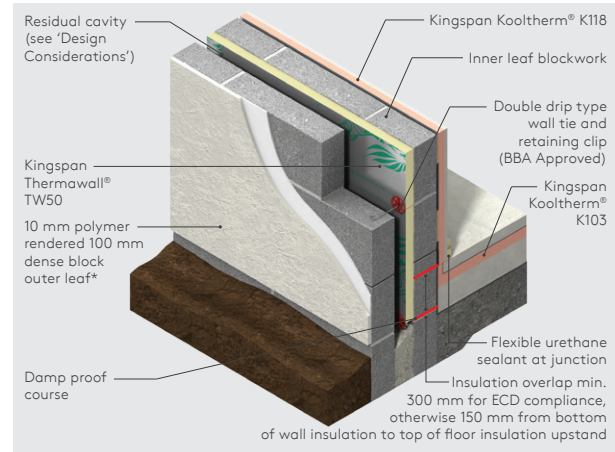

Figure 3

U-values (W/m <sup>2</sup> K) for various thicknesses of Kingspan Kooltherm® K118** and thicknesses of Kingspan Thermawall® TW50				
Thickness of Kingspan Thermawall® TW50 (mm)	Inner leaf blockwork density and λ-value (W/mK)			
	Dense (1.13)	Medium (0.51)	Lightweight (0.15)***	Aerated (0.11)***
37.5 mm Kingspan Kooltherm® K118**				
40	0.22	0.22	0.20	0.19
50	0.20	0.20	0.18	0.18
60	0.18	0.18	0.17	0.16
70	0.17	0.17	0.16	0.16
75	0.16	0.16	0.15	0.15
80	0.16	0.15	0.15	0.14
57.5 mm Kingspan Kooltherm® K118**				
50	0.17	0.16	0.15	0.21
60	0.15	0.15	0.14	0.14

\* Calculations assume dense block outer leaf of λ-value (1.13 W/mK).

\*\* Product thickness = insulant thickness + 12.5 mm plasterboard.

\*\*\* A 6.6% thermal bridging factor has been assumed for the effect of mortar joints.

NB Refer to local distributor or Kingspan Insulation price list for current stock and non-stock sizes.

# Typical constructions and U-values

## 102.5 mm brick outer leaf / 100 mm block inner leaf

Internal finish - fair faced blockwork

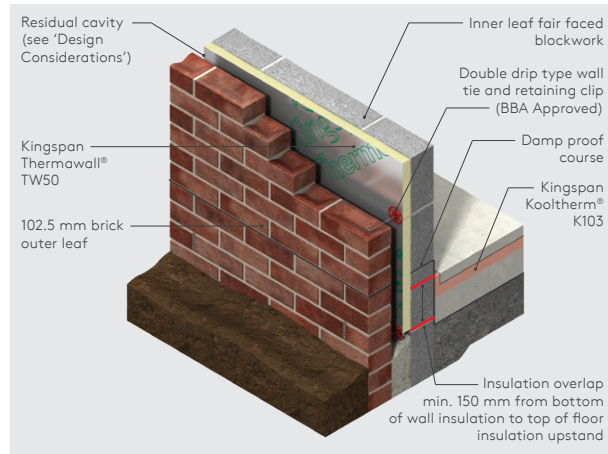

Figure 4

U-values (W/m <sup>2</sup> K) for various thicknesses of Kingspan Thermawall® TW50				
Insulant thickness (mm)	Inner leaf fair faced blockwork density and λ-value (W/mK)			
	Dense (1.13)	Medium (0.51)	Lightweight (0.15)*	Aerated (0.11)*
40	0.35	0.34	0.30	0.28
50	0.30	0.29	0.26	0.25
60	0.26	0.26	0.23	0.23
70	0.24	0.23	0.21	0.20
75	0.22	0.22	0.20	0.20
80	0.21	0.21	0.19	0.19
100	0.18	0.18	0.16	0.16

\* A 6.6% thermal bridging factor has been assumed for the effect of mortar joints.  
 NB Some values may have been omitted from the table because they do not meet the most common minimum requirements.  
 NB Refer to local distributor or Kingspan Insulation price list for current stock and non-stock sizes.

Internal finish - 3 mm skim coated 12.5 mm plasterboard

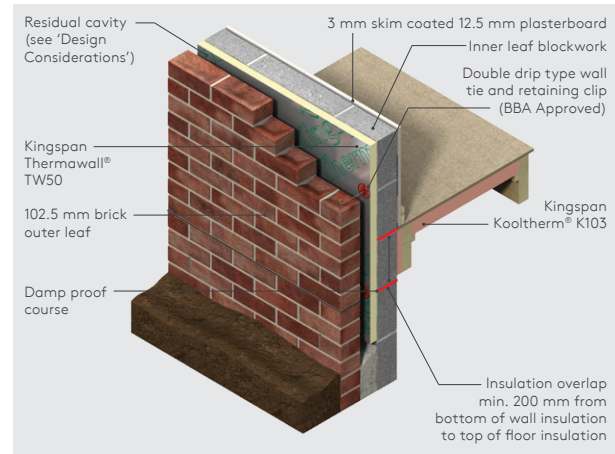

Figure 5

U-values (W/m <sup>2</sup> K) for various thicknesses of Kingspan Thermawall® TW50				
Insulant thickness (mm)	Inner leaf blockwork density and λ-value (W/mK)			
	Dense (1.13)	Medium (0.51)	Lightweight (0.15)*	Aerated (0.11)*
40	0.33	0.32	0.28	0.27
50	0.28	0.27	0.25	0.24
60	0.25	0.24	0.22	0.22
70	0.22	0.22	0.20	0.20
75	0.21	0.21	0.19	0.19
80	0.20	0.20	0.19	0.18
100	0.17	0.17	0.16	0.15

\* A 6.6% thermal bridging factor has been assumed for the effect of mortar joints.  
 NB Some values may have been omitted from the table because they do not meet the most common minimum requirements.  
 NB Refer to local distributor or Kingspan Insulation price list for current stock and non-stock sizes.

# Typical constructions and U-values

## Internal finish - Kingspan Kooltherm® K118

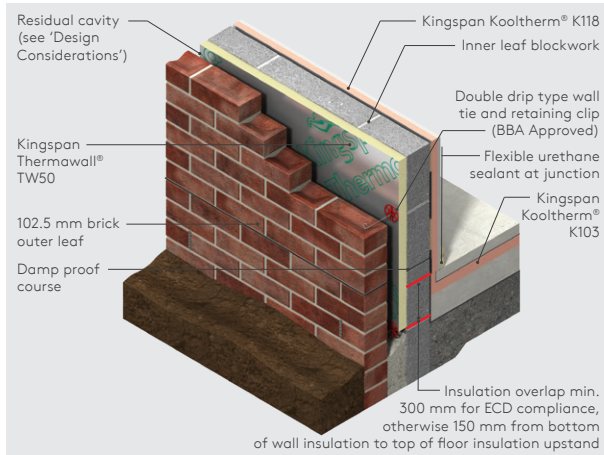

Figure 6

U-values (W/m <sup>2</sup> K) for various thicknesses of Kingspan Kooltherm® K118* and thicknesses of Kingspan Thermawall® TW50				
Thickness of Kingspan Thermawall® TW50 (mm)	Inner leaf blockwork density and λ-value (W/mK)			
	Dense (1.13)	Medium (0.51)	Lightweight (0.15)**	Aerated (0.11)**
37.5 mm Kingspan Kooltherm® K118*				
40	0.22	0.22	0.20	0.19
50	0.20	0.20	0.18	0.18
60	0.19	0.18	0.17	0.16
70	0.17	0.17	0.16	0.15
75	0.16	0.16	0.15	0.15
80	0.16	0.16	0.15	0.14
57.5 mm Kingspan Kooltherm® K118*				
50	0.17	0.16	0.15	0.15
60	0.15	0.15	0.14	0.14

\* Product thickness = insulant thickness + 12.5 mm plasterboard.

\*\* A 6.6% thermal bridging factor has been assumed for the effect of mortar joints.

NB Refer to local distributor or Kingspan Insulation price list for current stock and non-stock sizes.

## Heat loss and linear thermal bridging

### Basic principles

Linear thermal bridging describes the additional heat losses or gains that occur at junctions between elements e.g. where a cavity wall meets the ground or intermediate floor, or at junctions around openings in the building fabric where the thermal insulation layer is discontinuous e.g. sills, jambs and lintels.

Interruptions within the insulation layer by materials with poorer insulating properties can result in a thermal bridge, which in turn can lead to problems of internal surface condensation and mould growth, especially if there is a drop in surface temperature.

The heat flow at these junctions and opening locations, over and above that through the adjoining plane elements, is the linear thermal transmittance of the thermal bridge: measured in W/mK; referred to as a 'psi-value'; and expressed as a 'ψ-value'.

The lower the ψ-value, the better the performance. ψ-values are taken into account in the calculation methodologies e.g. the Standard Assessment Procedure (SAP) that are used to assess the operational CO<sub>2</sub> emissions and, where applicable, the fabric energy efficiency of buildings, primary energy or delivered energy rates.

ψ-values can comprise either, or a combination of, calculated and assumed values.

Approved details can uplift performance to provide a clear starting point towards achieving compliance, but can be limited in scope and applicability. The greatest opportunity for mitigating the impact of linear thermal bridges can come from following accurately 'modelled' details that take into account the following design considerations.

---

# Typical constructions and U-values

---

## Reducing linear thermal bridging

Detailing at junctions to minimise the effects of thermal bridging and the associated risk of condensation or mould growth is important and there are some simple design considerations that can be adopted to help mitigate the risks and to reduce heat losses.

- Care is required to ensure continuation of insulation wherever possible for best thermal performance. Where this is not possible, insulation layers should be overlapped and ideally, insulation material introduced between. In a standard cavity wall-to-ground floor junction the main linear thermal bridge is the inner leaf of masonry. This linear thermal bridge can be reduced by increasing the distance that the heat has to travel through the inner leaf of masonry. This can be achieved by means of overlapping the partial fill cavity wall insulation and the floor insulation.
- The key factor is the distance between the bottom of the cavity wall insulation and the top of the floor insulation (including any perimeter insulation upstand). In order to minimise cold bridging at the edge of ground floors, the distance between the top surface of the floor insulation or perimeter insulation upstand, and the bottom of the wall insulation must be a minimum of 150 mm for a concrete floor (see Figures 1 & 4) and 200 mm for a suspended timber floor (see Figures 2 & 5). The further appropriate wall insulation extends past the floor insulation, the better the thermal performance of the junction between the wall and the floor.
- Perimeter upstand insulation is extremely important for minimising heat losses from the junction with external walls. This helps to increase the path of heat flow and therefore helps reduce losses through the junction. Omitting this, or using a poorer performance insulation for this purpose, can increase these losses.
- Using better thermal performance 'lightweight' aggregate blockwork on the inner leaf in adjacency to the junction with the floor can also assist with assuring lower heat losses from the junction.
- An internal lining of insulation on the warm side of the construction such as Kingspan Kooltherm® K118, can also help to reduce heat losses.
- Prevention of thermal bridging should be considered when designing sills, jambs and lintels.
- Heat-loss from junctions around window or door openings can be further reduced by insulating the reveal. The key factor is the thermal resistance (R-value) of the insulation layer. Reveals should be designed to accommodate a minimal thickness of Kingspan Kooltherm® K118.
- For junctions between the external walls and roof constructions, continuity and overlap of insulation layers is the key to minimising heat losses from the junctions. Refer to Kingspan Thermapitch® TP10 literature for further design considerations.

For further advice on details to reduce linear thermal bridging please contact the Kingspan Insulation Technical Service Department (see rear cover for details).

---

# Design considerations

---

## Environmental impact & responsible Sourcing

### Environmental Product Declaration

An Environmental Product Declaration (EPD), certified by BRE Global to the BRE Environmental Profiles 2013 Product Category Rules for Type III environmental product declaration of construction products to BS EN 15804: 2012 + A1: 2013, has been created for Kingspan Thermawall TW50 produced at Kingspan Insulation's Pembridge (Herefordshire) and Selby (North Yorkshire) manufacturing facilities.

### Responsible sourcing

Kingspan Thermawall® TW50 produced at Kingspan Insulation's Pembridge, Herefordshire and Selby, North Yorkshire manufacturing facilities is certified to BES 6001 (Framework Standard for the Responsible Sourcing of Construction Products) 'Very Good'.



Kingspan Thermawall® TW50 is manufactured under a management system certified to ISO 14001: 2015.

NB The above information is correct at the time of writing. Please confirm at the point of need by visiting the Kingspan Insulation website (see rear cover), from which copies of Kingspan Insulation's certificates can be obtained.

## Sustainability & responsibility

Kingspan Insulation has a long-term commitment to sustainability and responsibility: as a manufacturer and supplier of insulation products; as an employer; as a substantial landholder; and as a key member of its neighbouring communities.

A report covering the sustainability and responsibility of Kingspan Insulation Ltd's operations at its Pembridge, Herefordshire and Selby, North Yorkshire manufacturing facilities is available at [www.kingspaninsulation.co.uk/sustainabilityandresponsibility](http://www.kingspaninsulation.co.uk/sustainabilityandresponsibility).

## Specification clause

Kingspan Thermawall® TW50 should be described in specifications as:

The cavity wall insulation shall be Kingspan Thermawall® TW50 \_\_\_\_ mm thick: comprising a high performance fibre-free rigid thermoset insulation core faced on both sides with a low emissivity composite foil facing. The product shall be manufactured: with a blowing agent that has zero Ozone Depletion Potential (ODP) and low Global Warming Potential (GWP); in accordance with the requirements of BS EN 13165: 2012 + A2: 2016; under a management system certified to ISO 9001: 2015, ISO 14001: 2015, ISO 45001: 2018 and ISO 50001: 2018; by Kingspan Insulation Limited; and installed in accordance with the instructions issued by them.

## Product classifications

### Uniclass UK

Pr\_25\_31\_28\_65 Polyisocyanurate (PIR) foam insulation  
Pr\_25\_71\_63\_66 Polyisocyanurate (PIR) foam boards  
Pr\_80\_77\_76\_65 Polyisocyanurate (PIR) insulation

### CAWS

F30 155 (Standard and Intermediate)  
F30 12 (Minor Works)

Details also available at [source.thenbs.com](http://source.thenbs.com).

## Building Information Modelling (BIM)

Kingspan Insulation's BIM objects can be downloaded in Revit and in IFC formats. For more information please visit [www.kingspaninsulation.co.uk/bim](http://www.kingspaninsulation.co.uk/bim).

## Design standards

BS EN 845-1: 2013 + A1: 2016 (Specification for ancillary components of masonry. Wall ties, tension straps, hangers and brackets), BS EN 1996-1-1: 2005 + A1: 2012 (Eurocode 6. Design of masonry structures. General rules for reinforced and unreinforced masonry structures), BS EN 1996-2: 2006 (Eurocode 6. Design of masonry structures. Design considerations, selection of materials and execution of masonry), BS EN 1996-3: 2006 (Eurocode 6. Design of masonry structures. Simplified calculation methods for unreinforced masonry structures) and PD 6697: 2019 (Recommendations for the design of masonry structures to BS EN 1996-1-1 and BS EN 1996-2) should be consulted regarding the construction of insulated cavity walls.

---

# Design considerations

---

## Residual cavity width

A minimum 25 mm residual cavity width is recommended between the insulation and the outer leaf for wall heights up to 12 metres. A minimum 50 mm residual cavity width is recommended for wall heights greater than 12 metres and up to and including 25 metres. For further details please refer to current BBA Certificate 14/5133.

The NHBC and / or Zurich Building Insurance Technical Standards normally require a minimum 50 mm residual cavity width in areas of severe exposure to wind driven rain (exposure zone 3) and a minimum 75 mm residual cavity width in areas of very severe exposure to wind driven rain (exposure zone 4), where nominal standards of tolerance and workmanship are accepted. The NHBC and/or Zurich Building Insurance Technical Standards are able to accept a 50 mm residual cavity width for Kingspan Thermawall® TW50 in all exposure zones including areas of very severe exposure to wind driven rain (exposure zone 4) where the outer leaf is fair faced masonry with tool flush joints.

## Wall ties

Wall ties should have a retaining clip for securing the insulant to the masonry plane and be of a double drip type. Ideally they should be BBA / NSAI approved and conform to BS EN 845-1: 2013 + A1: 2016 (Specification for ancillary components of masonry. Wall ties, tension straps, hangers and brackets), BS EN 1996-1-1: 2005 + A1: 2012 (Eurocode 6. Design of masonry structures. General rules for reinforced and unreinforced masonry structures), BS EN 1996-2: 2006 (Eurocode 6. Design of masonry structures. Design considerations, selection of materials and execution of masonry), BS EN 1996-3: 2006 (Eurocode 6. Design of masonry structures. Simplified calculation methods for unreinforced masonry structures) and PD 6697: 2010 (Recommendations for the design of masonry structures to BS EN 1996-1-1 and BS EN 1996-2).

---

## Lightning protection

Building designers should give consideration to the requirements of BS EN 62305-1: 2011 (Protection against lightning).



# Sitework

- Kingspan Thermawall® TW50 features a foil on both sides and therefore can be installed with either side facing outwards.
- There are potential restrictions placed upon this product which vary dependant on building type, height, construction and location in Great Britain. For guidance regarding the routes to compliance for meeting the fire safety requirements of the Building Regulations / Standards in Great Britain, refer to the relevant links to Government websites at [www.kingspaninsulation.co.uk/fireregulations](http://www.kingspaninsulation.co.uk/fireregulations).

## Fixing details

- Kingspan Thermawall® TW50 is normally held in position by the wall ties used to tie the two skins of masonry together.
- Wall ties should include a retaining disc / clip and be of the double drip type, installed drip downward.
- For a solid concrete ground floor the first row of wall ties are installed in the inner leaf at 600 mm horizontal centres a minimum of one course of blockwork below the damp proof course or 150 mm below the top surface of the ground floor perimeter insulation upstand (see 'Heat Loss and Linear Thermal Bridging' above), whichever is the lower.
- For a suspended timber floor the first row of wall ties are installed in the inner leaf at 600 mm horizontal centres a minimum of 200 mm below the top surface of the ground floor perimeter insulation upstand (see 'Heat Loss and Linear Thermal Bridging' above).
- Continue constructing the inner leaf up to the next wall tie course (450 mm above the first - usually 2 block courses).
- The next course of wall ties is positioned at the usual 900 mm horizontal centres in the UK.
- The next course of blockwork is installed to secure the ties.
- The first row of insulation boards should now be installed between the two rows of wall ties, ensuring each insulation board is retained tight against the inner leaf and joints are lightly butted.
- Each board should be secured at a minimum of three points. Additional ties may also be required to satisfy the structural requirements of BS EN 845-1: 2013 + A1: 2016, BS EN 1996-1-1: 2005 + A1: 2012, BS EN 1996-2: 2006, BS EN 1996-3: 2006, PD 6697: 2019 and / or to ensure adequate retention of boards or cut pieces.
- The outer leaf is then built up to the level of the top of the boards and the process is repeated.
- When insulating a gable, insulation boards should be continued 250 mm beyond the height of the top storey ceiling and a cavity tray installed above the insulation.

## Excess mortar

- After raising each section of inner leaf, before installation of the insulation board, excess mortar should be removed and mortar droppings cleaned from exposed edges of the installed insulation boards.
- Use of a cavity batten or cavity board is recommended to protect board edges and maintain a clear cavity (see Figures 7 & 8 or refer to BBA Certificate 14/5133 or NSAI Agrément Certificate 03/0196).

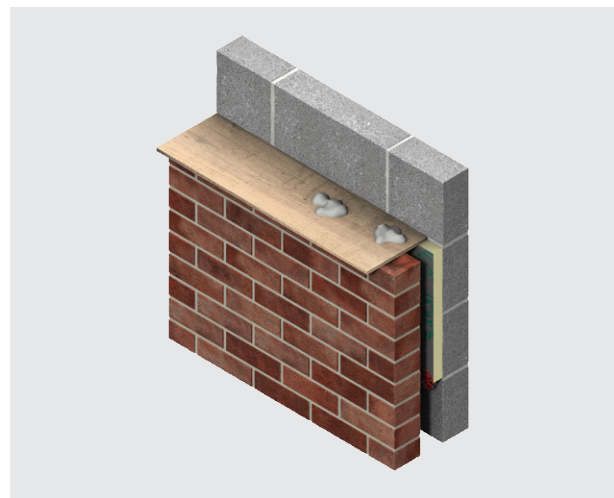

Figure 7 - Use of a cavity board to protect the cavity and insulation board top edge

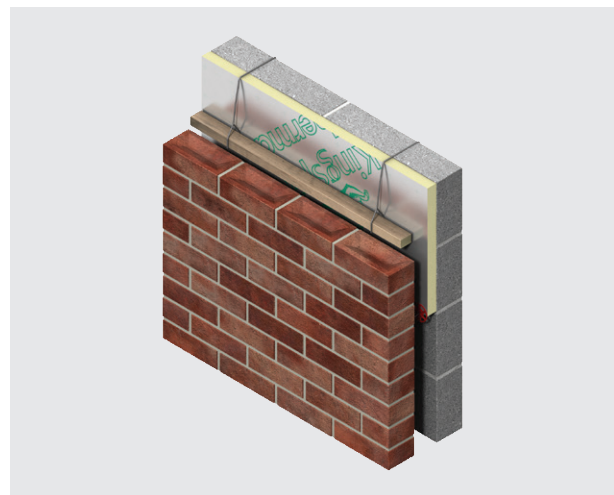

Figure 8 - Use of a cavity batten to protect the cavity

---

# Sitework

---

## General

### Cutting

- Cutting should be carried out either by using a fine toothed saw, or by scoring with a sharp knife, snapping the board over a straight edge and then cutting the facing on the other side.
- Ensure accurate trimming to achieve close butting joints and continuity of insulation.

### Daily working practice

- At the completion of each day's work, or whenever work is interrupted for extended periods of time, board edges and joints should be protected from inclement weather.

### Availability

- Kingspan Thermawall® TW50 is available through specialist insulation distributors and selected builders' merchants throughout the UK.

### Packaging and storage

- The polyethylene packaging of Kingspan Insulation products, which is recyclable, should not be considered adequate for outdoor protection.
- Ideally, boards should be stored inside a building. If, however, outside storage cannot be avoided, then the boards should be stacked clear of the ground and covered with an opaque polythene sheet or weatherproof tarpaulin. Boards that have been allowed to get wet should not be used.

## Health and safety

- Kingspan Insulation products are chemically inert and safe to use.
- A Safety Information Data Sheet for this product is available from the Kingspan Insulation website [www.kingspaninsulation.co.uk/safety](http://www.kingspaninsulation.co.uk/safety).

Please note that the reflective surfaces on this product are designed to enhance its thermal performance. As such, they will reflect light as well as heat, including ultraviolet light. Therefore, if this product is being installed during very bright or sunny weather, it is advisable to wear UV protective sunglasses or goggles, and if the skin is exposed for a significant period of time, to protect the bare skin with a UV block sun cream.

The reflective facings used on this product can be slippery when wet. Therefore, it is recommended that any excess material should be contained to avoid a slip hazard.

Warning - do not stand on or otherwise support your weight on this product unless it is fully supported by a load bearing surface.

# Product details

## The facings

Kingspan Thermawall® TW50 is faced on both sides with a low emissivity composite foil, autohesively bonded to the insulation core during manufacture. This reflective, low emissivity surface improves the thermal resistance of any unventilated cavity adjacent to the board.

## The core

The core of Kingspan Thermawall® TW50 is manufactured with Nilflam® technology. The core is a high performance fibre-free rigid thermoset polyisocyanurate (PIR) insulant manufactured with a blowing agent that has zero Ozone Depletion Potential (ODP) and low Global Warming Potential (GWP).



## Standards and approvals

Kingspan Thermawall® TW50 is manufactured to the highest standards in accordance with the requirements of BS EN 13165: 2012 + A2: 2016 (Thermal insulation products for buildings. Factory made rigid polyurethane foam (PU) products. Specification).

Kingspan Thermawall® TW50 is also manufactured under a management system certified to ISO 9001: 2015 (Quality Management System), ISO 14001: 2015 (Environmental Management System), ISO 45001: 2018 (Occupational Health and Safety Management System) and ISO 50001: 2018 (Energy Management System).

The use of Kingspan Thermawall® TW50 (in thicknesses of 25 - 120 mm) produced at Kingspan Insulation's Pembridge, Herefordshire and Selby, North Yorkshire manufacturing facilities is covered by BBA Certificate 14/5133.



## Standard dimensions

Kingspan Thermawall® TW50 is available in the following standard size(s):

Nominal Dimension		Availability
Length	(m)	1.2
Width	(m)	0.45
Insulant Thickness	(mm)	Refer to local distributor or Kingspan Insulation price list for current stock and non-stock sizes.

## Compressive strength

The compressive strength of Kingspan Thermawall® TW50 typically exceeds 140 kPa at 10% compression, when tested to BS EN 826: 2013 (Thermal insulating products for building applications. Determination of compression behaviour).

## Water vapour resistance

The product typically achieves a resistance for greater than 100 MNs/g, when tested in accordance with BS EN 12086: 2013 (Thermal insulating products for building applications. Determination of water vapour transmission properties).

## Durability

If correctly installed, Kingspan Thermawall® TW50 can have an indefinite life. Its durability depends on the supporting structure and the conditions of its use.

## Resistance to solvents, fungi & rodents

The insulation core is resistant to short-term contact with petrol and with most dilute acids, alkalis and mineral oils. However, it is recommended that any spills be cleaned off fully before the boards are installed. Ensure that safe methods of cleaning are used, as recommended by suppliers of the spilt liquid. The insulation core is not resistant to some solvent-based adhesive systems, particularly those containing methyl ethyl ketone. Adhesives containing such solvents should not be used in association with this product. Damaged boards or boards that have been in contact with harsh solvents or acids should not be used.

The insulation core and facings used in the manufacture of Kingspan Thermawall® TW50 resist attack by mould and microbial growth and do not provide any food value to vermin.

---

# Product details

---

## Fire performance

There are restrictions placed upon this product which vary dependant on building type, height, construction and location in Great Britain. For more information regarding the routes to compliance for meeting the fire safety requirements of the Building Regulations / Standards in Great Britain, refer to the relevant Technical Bulletins and links to Government websites at [www.kingspaninsulation.co.uk/fireregulations](http://www.kingspaninsulation.co.uk/fireregulations).

Under System 4 AVCP, Kingspan Thermawall® TW50 has a Euroclass rating of F.

Further details on the fire performance of Kingspan Insulation products may be obtained from the Kingspan Insulation Technical Service Department (see rear cover).

---

## Thermal properties

The  $\lambda$ -values and R-values detailed below are quoted in accordance with BS EN 13165: 2012 + A2: 2016 (Thermal insulation products for buildings. Factory made rigid polyurethane foam (PU) products. Specification).

### Thermal conductivity

The boards achieve a thermal conductivity ( $\lambda$ -value) of 0.022 W/mK.

### Thermal resistance

Thermal resistance (R-value) varies with thickness and is calculated by dividing the thickness of the board (expressed in metres) by its thermal conductivity. The resulting number is rounded down to the nearest 0.05 (m<sup>2</sup>K/W).

Insulant thickness (mm)	Thermal resistance (m <sup>2</sup> K/W)
40	1.80
50	2.25
60	2.70
70	3.15
75	3.40
80	3.60
100	4.50

NB Refer to local distributor or Kingspan Insulation price list for current stock and non-stock sizes.

---

# About Kingspan Insulation

---

## Company details

Kingspan Insulation Ltd is part of the Kingspan Group plc., one of Europe's leading construction product manufacturers. The Kingspan Group was formed in the late 1960s and is a publicly quoted group of companies headquartered in Kingscourt, County Cavan, Ireland.

Kingspan Insulation Ltd is a market leading manufacturer of premium and high performance rigid insulation products and insulated systems for building fabric and building services applications.

---

## Products & solutions

Optimum, premium and high performance rigid insulation products for building fabric applications, including roofs, walls and floors.

- Kingspan OPTIM-R® - optimum performance vacuum insulation panel (VIP) systems.
- Kingspan Kooltherm® - premium performance phenolic insulation.
- Kingspan Therma™ - high performance PIR insulation.
- K-Roc® - rock mineral fibre insulation.
- Kingspan GreenGuard® - extruded polystyrene insulation (XPS).
- Kingspan TEK® - structural insulated panels (SIPs).
- Cavity closers - PVC-U extrusions with an insulation core.
- Membranes - for pitched roofs and walls.

## Services

We are proud to offer one of the most advanced support services in the construction industry, designed to give fast and accurate advice no matter what your role is. Visit our website to access the following services.

- U-value calculations - free, quick and easy U-value calculations with our U-value Calculator.
- Help and advice on your projects, including stockists, how to guides, regulatory guidance and e-learning.
- Building Information Modelling (BIM) - download BIM objects for our products.
- Tapered roofing service - Kingspan Insulation's tapered roofing systems come with a supporting design service to ensure the most cost-effective solution for a roof is identified.
- CPDs - Kingspan Insulation offer a number of free CPD seminars for architects and specifiers covering a wide range of industry topics. CPDs can be booked or a range of online learning courses can be found online.

---

## Planet Passionate

Planet Passionate is our 10-year group wide global sustainability strategy aims to impact on three big global issues: climate change, circularity and protection of our natural world.

The Planet Passionate strategy is made up of 12 ambitious targets, addressing the impact of Kingspan's business operations and manufacturing on the four key areas of energy, carbon, circularity and water, with commitments by 2030 to include:

- energy: powering 60% of all Kingspan operations directly from renewable energy with a minimum of 20% of this energy generated on manufacturing sites;
- carbon: achieving net zero carbon manufacturing and a 50% reduction in product CO<sub>2</sub> intensity from primary supply partners;
- circularity: upcycling of 1 billion PET bottles per annum into insulation products plus zero company waste to landfill across all sites; and
- water: harvesting 100 million litres of Kingspan's water usage from rainwater.

---

# Contact details

---

## Kingspan Insulation Ltd

Pembridge | Leominster  
Herefordshire | HR6 9LA

T: +44 (0) 1544 388 601

F: +44 (0) 1544 388 888

E: [info@kingspaninsulation.co.uk](mailto:info@kingspaninsulation.co.uk)

[www.kingspaninsulation.co.uk](http://www.kingspaninsulation.co.uk)

For individual department contact details please visit

[www.kingspaninsulation.co.uk/contact](http://www.kingspaninsulation.co.uk/contact)

To check that you have the latest version of this brochure please visit  
[www.kingspaninsulation.co.uk/downloads](http://www.kingspaninsulation.co.uk/downloads).

To access pre-existing product information or information relating to previously sold/discontinued products please email [literature@kingspaninsulation.co.uk](mailto:literature@kingspaninsulation.co.uk).

The information contained in this brochure is believed to be correct at the date of publication. Kingspan Insulation Limited ("Kingspan Insulation") reserves the right to alter or amend the product specifications without notice due to continuous improvement commitments. There may also be relevant changes between publications with regard to legislation, or other developments affecting the accuracy of the information contained in this brochure. Product thicknesses shown in this document should not be taken as being available ex-stock and reference should be made to the current Kingspan Insulation price-list or advice sought from Kingspan Insulation's Customer Service Department. The information, technical details and fixing instructions etc. included in this literature are given in good faith and apply to uses described. Kingspan Insulation does not accept responsibility for issues arising from using products in applications different from those described within this brochure or failure to correctly follow the information or instructions as described within this brochure. Recommendations for use should be verified with a suitable expert or professional for suitability and compliance with actual requirements, specifications and any applicable laws and regulations. For other applications or conditions of use, Kingspan Insulation offers a technical advisory service (see above for contact details), the advice of which should be sought for uses of Kingspan Insulation products that are not specifically described herein. Please check that your copy of this literature is current by contacting the Kingspan Insulation Marketing Department.

© Kingspan, Kingspan GreenGuard, KoolDuct, Kooltherm, Nilflam, nilvent, OPTIM-R, TEK, Thermawall and the Lion Device are Registered Trademarks of the Kingspan Group plc in the UK, Ireland and other countries. All rights reserved.

TM Therma is a Trademark of the Kingspan Group plc.

Kingspan Insulation Ltd is not associated with, and its products have not necessarily been tested by, the GREENGUARD Environmental Institute.

Registered in England & Wales, No. 01882722. Registered Office: Pembridge, Leominster, Herefordshire HR6 9LA UK. VAT GB428602456.

