

Flat Fixed Rooflight

Standard Stock Size 1000mm x 3000mm

Kerb/Upstand Sizes (by others)

Internal Kerb Upstand Size 1000mm x 3000mm

External Kerb/Upstand Size 1160mm x 3160mm

Kerb/Upstand thickness 80mm (including weathering)

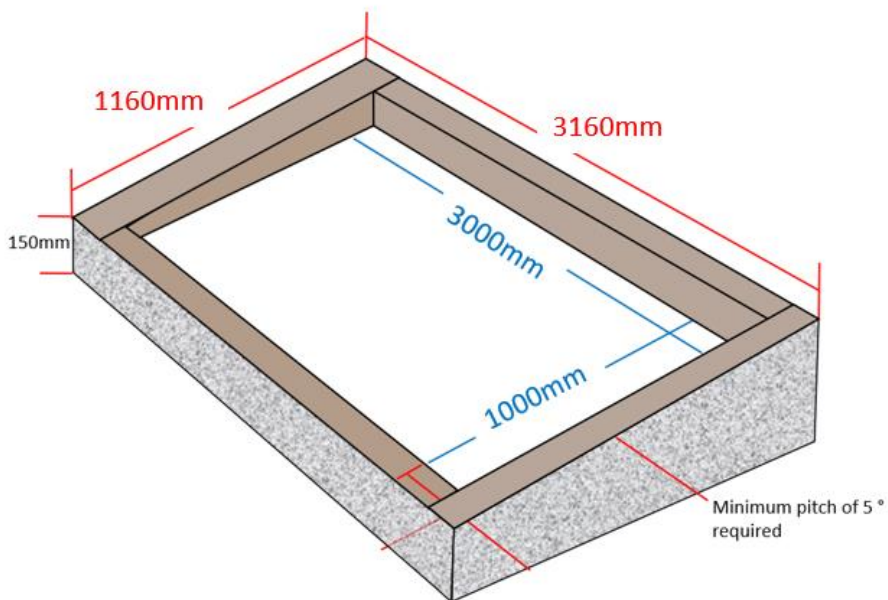

Fixed Rooflight Sizes

Internal Opening Size 1000mm x 3000mm

External Frame Size 1181mm x 3181mm

Frame Height 119mm

