

FLAT ROOFING SOLUTIONS

ROCKWOOL HARDROCK® Multi-Fix Dual Density boards provide unique tested solutions for fire, thermal and acoustic roofing systems for all building types.

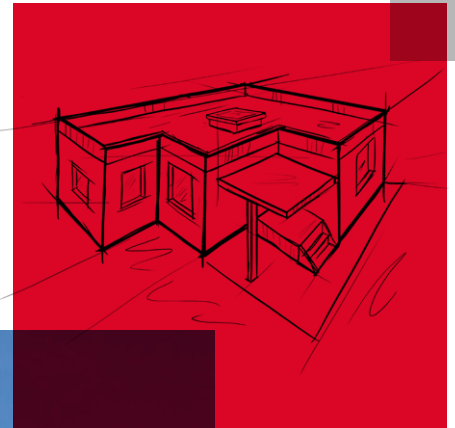

Image courtesy of GSS Architecture - www.gssarchitecture.com

FLAT ROOFING SOLUTIONS

ROCKWOOL HARDROCK® Multi-Fix Dual Density boards are manufactured from renewable volcanic stone which produces a non-combustible roofing insulation board.

4 benefits beyond thermal:



Unmatched fire resistance

Euroclass A1 - non-combustible insulation



Superior acoustics

Excellent airborne, sound absorption & impact reduction performance



Sustainable materials

ROCKWOOL insulation is 97% recyclable



Unrivalled durability

Long term stable thermal performance



Certificate No EMS 20001

THE NATIONAL FEDERATION OF ROOFING CONTRACTORS LIMITED

Description

A uniquely versatile solution suitable for all roof covering types - torch, pour and roll, single ply, EPDM, liquid applied and green roofs - new-build and refurbishment.

Standards and approvals

ROCKWOOL HARDROCK® Multi-Fix (DD) roofing boards comply with the requirements of BS EN 13162, 'Thermal insulation products for buildings, factory made mineral wool (MW) products specification.'

European Union of Agreement (UEAtc)

HARDROCK® Multi-Fix (DD) roofing boards have been assessed by the British Board of Agreement to UEAtc technical guidelines MOAT No 50: 1992 'Thermal insulation systems intended for supporting waterproof coverings on flat and sloping roofs'.

HARDROCK® Multi-Fix (DD) boards have been tested for the effects of mechanical stress, and has achieved Classification C 'Roof accessible to pedestrian traffic and may be used where frequent maintenance of equipment is envisaged'.

Sustainability

As an environmentally conscious company, ROCKWOOL promotes the sustainable production and use of insulation and is committed to a continuous process of environmental improvement.

All ROCKWOOL products provide four benefits beyond thermal performance.



Unmatched fire resistance



Superior acoustics



Unrivalled durability



Sustainable materials

Health and safety

In accordance with REACH health and environment regulations, there are no hazardous classifications associated with ROCKWOOL mineral wool in respect to physical, health and environmental considerations.

Advantages

- The product presents no smoke hazard, and will not contribute to fire growth in any stages of a fire (including the fully developed stage of a fire)
- The product is deemed to be non-combustible in accordance with UK building regulations complying with Zurich School and Academy Design guide and HTM05-03 guidance for healthcare
- LPCB approved to highest classification, LPS1181: Part 1 EXT – A rated constructions
- Excellent acoustic reduction, absorption and impact (rain noise) performance
- Solutions to meet all BB93 (Education) and HTM08-01 (Healthcare) acoustic requirements
- Acoustic solutions provide opportunity for additional BREEAM points
- Dimensionally stable
- Consistent thermal performance with no blowing agents. Zero ODP and GWP
- HARDROCK® Multi-Fix (DD) can be recycled and reprocessed reducing landfill and cost

Environment

Relying on entrapped air for its thermal properties, ROCKWOOL insulation does not contain (and has never contained) gases that have ozone depleting potential (ODP) or global warming potential (GWP). ROCKWOOL therefore complies with the relatively modest threshold of GWP<5 included in documents such as the [Code for Sustainable Homes](#).

ROCKWOOL offer a recycling service for the HARDROCK® Multi-Fix (DD) roof boards.

We are happy to discuss the individual requirements of contractors and users considering returning ROCKWOOL materials to our factory for recycling.

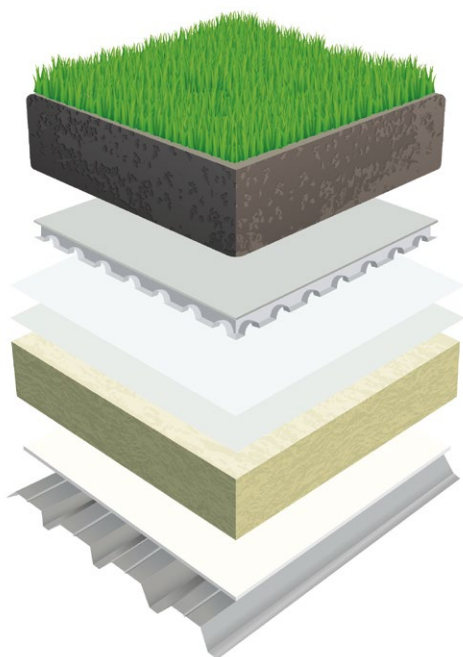

Typical applications

HARDROCK® Multi-Fix (DD) roofing boards are fully compatible for use with the following roofing systems:

- Fully bonded, partially bonded, mechanically fastened single ply membrane systems and EPDM membrane systems
- Torch applied, bitumen based and mastic asphalt built up systems
- Liquid applied systems
- Green roof systems

ROCKWOOL Acoustic Membrane is a high density polymer mass layer that combines with Hardrock® Multi-Fix (DD) to offer enhanced acoustic performance for the very highest specifications. ROCKWOOL Acoustic Infills are available as plain, tissue faced or melinex faced trapezoidal shaped perforated metal deck infills, used as part of the system to enhance acoustic absorption.

The HARDROCK® Multi-Fix (DD) roofing board range

HARDROCK® Multi-Fix (DD) base board (plain)

Application	Primary base layer for all systems
Board size	1200mm x 1000mm
Standard thickness	150mm

HARDROCK® Multi-Fix (DD) fleece faced

Application	Torch applied, pour and roll bitumen, single ply and EPDM mechanical or adhered systems, liquid applied systems and green roof
Board size	1200mm x 1000mm
Standard thickness	60, 85, 105, 115, 150, 170, 185mm

HARDROCK® Multi-Fix (DD) tapered roof system

Application	All
Board size	1200mm x 1000mm
Standard thickness	Individually designed to meet scheme requirements

ROCKWOOL Multi-Fix acoustic flat roof system ancillaries

ROCKWOOL Acoustic Membrane 5kg

Application	High specification lightweight roofing systems
Board size	1220mm x 6000mm
Standard thickness	2.5mm

ROCKWOOL Acoustic Membrane 10kg

Application	High specification lightweight roofing systems
Board size	1220mm x 4050mm
Standard thickness	5mm

ROCKWOOL Acoustic Infill sound absorbers

Application	Perforated metal decks
Board size	1000mm length shaped to suit all deck profiles

Product performance

Thermal performance

The thermal conductivity of HARDROCK® Multi-Fix roofing boards is 0.039 W/mK (λ 90:90).

Resistance to moisture

ROCKWOOL products consist of randomly orientated water repellent fibres that prevent moisture from working its way into the board.

Should any boards become wet during installation they should be allowed to dry out naturally, prior to applying the roof membrane.

Dimensional stability

HARDROCK® Multi-Fix (DD) roofing boards are dimensionally stable when tested to EN 1604 and therefore do not exert any undesirable stress on the fixings or waterproof membrane.

Fire performance

As well as achieving a European Reaction to Fire Classification of A1, HARDROCK® Multi-Fix (DD) roofing boards offer a high level of fire protection and are classified as non-combustible in accordance with UK Building Regulations and LPCB (Red Book ref. 022g).

Rapid spread of fire not only destroys buildings, but can also cost lives and destroy businesses. Smoke and fumes can hinder escape and rescue. The specification of insulation materials should consider each characteristic as well as any tendency for toxic emissions to contaminate water courses and the environment.

LPCB approvals

Roofing constructions incorporating HARDROCK® Multi-Fix (DD) roofing boards have achieved the highest possible classification to LPS 1181:Part1 (i.e. EXT-A). This was accomplished by successfully undertaking and

passing the Part 1 test for Reaction to Fire and the more onerous LPS 1208 Resistance to Fire test. HARDROCK® Multi-Fix roofing boards are the only insulation products to have achieved this classification, in respect of built-up warm flat roofing constructions.

- Fire resistance performances up to 120 minutes (integrity and insulation) to BS 476: Part 21 can be achieved
- The insulation must always be installed as a double layered system.
- The joints between each layer should be staggered and the LPCB approval covers thicknesses up to 210mm.
- The grades and performances are valid for both flat and tapered systems.
- Tapered systems are covered by the LPCB approval where a 2-layer system is employed and the minimum thickness of the upper board is 40mm-60mm with a flatboard below.

Euroclass classifications

As of July 2013, it became mandatory for all insulation manufacturers to label their products with their Euroclass reaction-to-fire classification. For confirmation of a construction product's Euroclass classification (as placed onto the market) refer to the CE mark label on the packaging or the Declaration of Performance (DoP) found on the manufacturer's website.

Unlike some other insulation materials on the market today, ROCKWOOL stone wool insulation is A1 non-combustible. To view the DoP for HARDROCK® Multi-Fix (DD) visit www.rockwool.com/dop.

If you want to learn more about the Euroclass reaction to fire classification system and how to ensure your building project is adequately protected from fire contact us for a CPD session.

Product	Thickness range (mm)	Grade	Fire resistance integrity (mins)	Fire resistance insulation (mins)
Fleece faced - for mechanically fastened single ply external membranes	100-135	EXT-B & EXT-A60	60	60
	140-205	EXT-B & EXT-A90	90	90
	210	EXT-B & EXT-A120	120	120
Fleece faced Multi-Fix - for fully adhered single ply external membranes	100-135	EXT-B & EXT-A60	60	60
	140-205	EXT-B & EXT-A90	90	90
	210	EXT-B & EXT-A120	120	120

Table above provides details of LPCB fire approvals to LPS 1181:Part 1 for HARDROCK® Multi-Fix (DD) roofing boards

Superior acoustics

ROCKWOOL has a unique in-house design capability to provide bespoke project specific rain noise calculations and can support with a comprehensive suite of absorption and sound attenuation test data. The service will support cost effective project design and help meet the Education acoustic requirements, BB93.

Sound absorption

Reflected sound is often a problem experienced in most buildings, for example:

- Schools
- Airport terminals
- Retail centres
- Manufacturing facilities

The use of ROCKWOOL Acoustic Infills in conjunction with HARDROCK® Multi-Fix (DD) roofing boards improves sound absorption within the building, improving the environment for work and leisure ([refer to page 11](#)).

Sound attenuation

Noise intrusion from external sources such as heavy traffic or aircraft can be reduced by using HARDROCK® Multi-Fix (DD) roofing systems, creating a quieter ambience within the building. The use of our Acoustic Membrane may be required for high performance acoustic specifications.

Using a combination of HARDROCK® Multi-Fix (DD) and ROCKWOOL Acoustic Membrane will result in improved sound insulation levels across the frequency range. ROCKWOOL roof systems only require this additional mass layer for the most onerous acoustic specifications due to the impressive acoustic properties of the Multi-Fix board ([refer to page 12 for further information](#)).

Rain noise

Excessive noise from rain on a lightweight roof construction can result in noise radiating into the working ceiling or habitable space below.

Therefore, noise caused by rainfall is an important factor to consider at an early point in the roof design stage, and preventative steps should be applied to minimise disturbance within the building.

The solution – specify a single or double layer of ROCKWOOL HARDROCK® Multi-Fix (DD) roofing board to solve this problem. For very high levels of acoustic treatment, the performance can be further enhanced with the addition of a ROCKFON® ceiling or a layer of ROCKWOOL® Acoustic Membrane.

Building Bulletin 93 'Acoustic design of schools' outlines the methods of compliance; this includes a requirement to minimise the noise of rainfall on lightweight roofs. Methods of control must be included and approved by Building Control.

BREEAM Schools

The Building Research Establishment Environmental Assessment Method (BREEAM) under health and well-being, acoustic performance (HW17), stipulates that credits will be awarded for new build and refurbishment projects where the indoor ambient noise levels (defined in table 1.1, BB93) during 'heavy' rainfall are exceeded by no more than 20dB in the design calculations. For lightweight flat roof constructions, this most onerous requirement may be achieved by a combination of HARDROCK® Multi-Fix (DD) roofing boards and ROCKFON® acoustic ceilings, where required.

For support, advice and design assistance with your projects please contact ROCKWOOL Technical Solutions on 01656 868 490.



Image courtesy of GSS Architecture - www.gssarchitecture.com

Single ply/EPDM roofing - Systems

Example 1 - Single layer system (Partial/fully bonded or mechanically fixed)

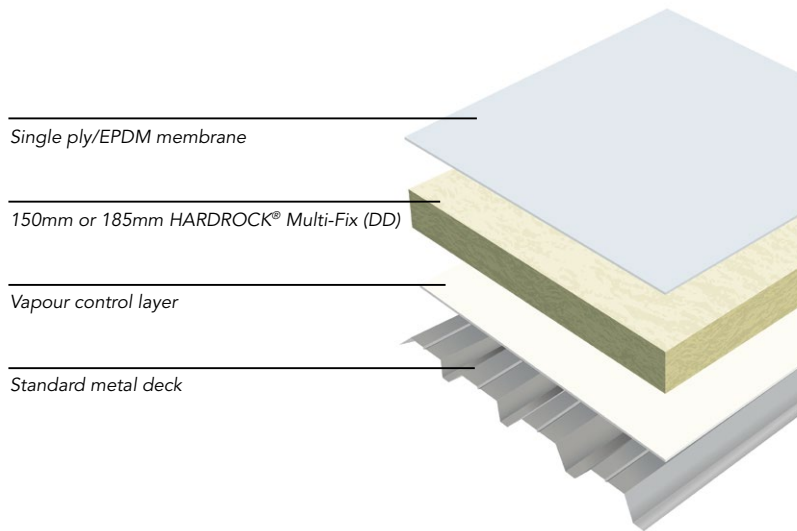

System performance information

Acoustic performance 1
 Rw 35dB/52dB LiA rain impact noise*
 (Rw figure excludes suspended ceilings)

Example room types & usage
 Primary/Secondary school classrooms (BB93)

Acoustic performance 2 (with acoustic membrane 5kg)
 Rw 38dB/52dB LiA rain impact noise*
 (Rw figure excludes suspended ceilings)

Example room types & usage
 Music Room (BB93)

Thermal performance
 0.25W/m²K and 0.20 W/m²K

Example 2 - Dual layer system (Partial/fully bonded or mechanically fixed)

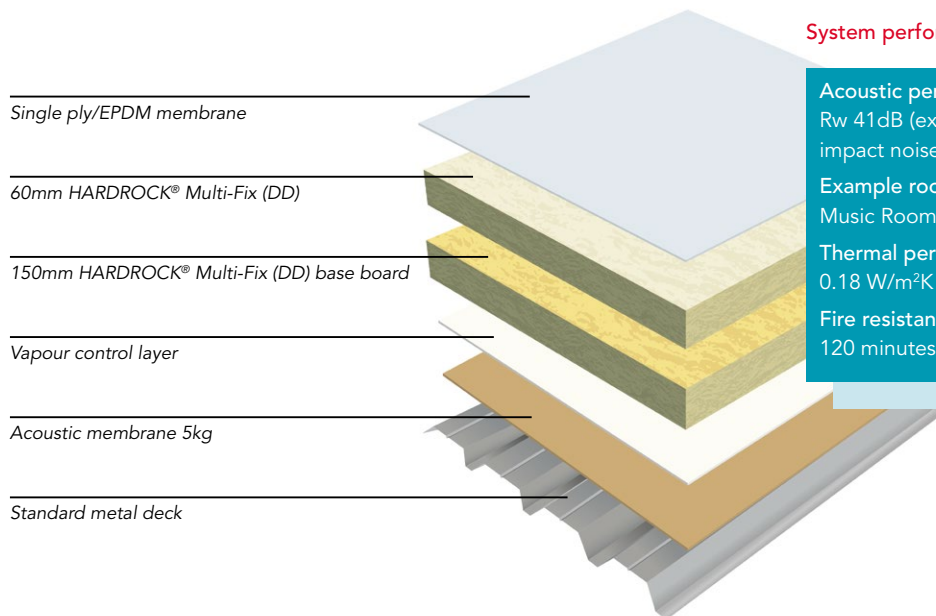

System performance information

Acoustic performance (with acoustic membrane 5kg)
 Rw 41dB (excludes suspended ceilings) 52dB LiA rain impact noise*

Example room types & usage
 Music Room (BB93)

Thermal performance
 0.18 W/m²K

Fire resistance
 120 minutes (integrity & insulation)

Single ply/EPDM roofing - Systems

Example 3 - Dual layer, perforated deck system (Partial/fully bonded or mechanically fixed)

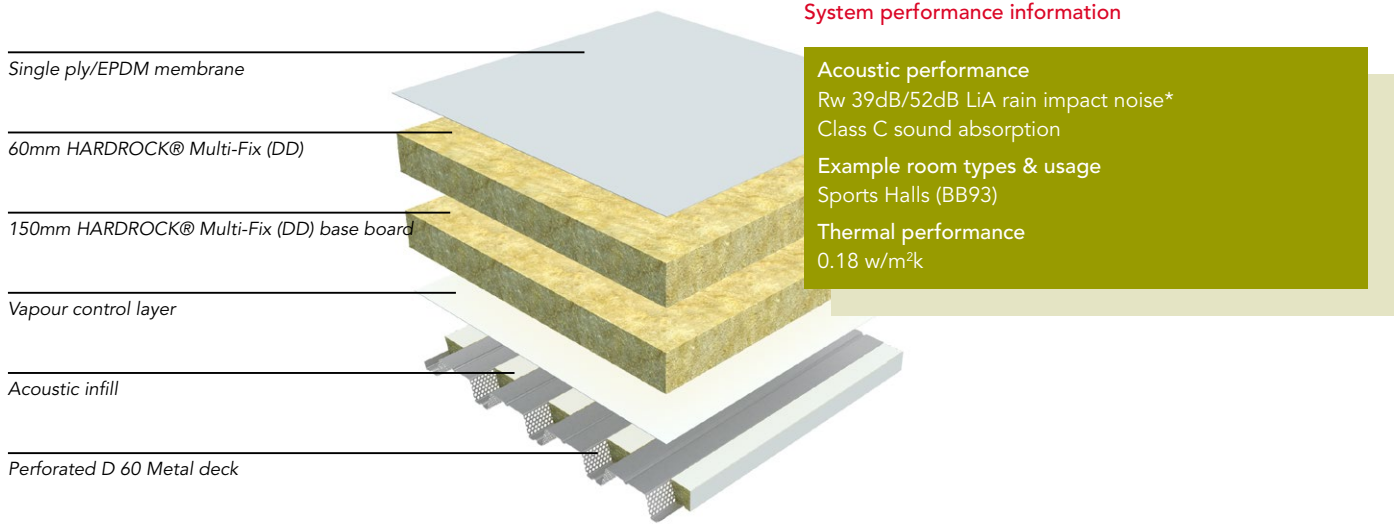

Example 4 - Single ply green roof (Partial/fully bonded or mechanically fixed)

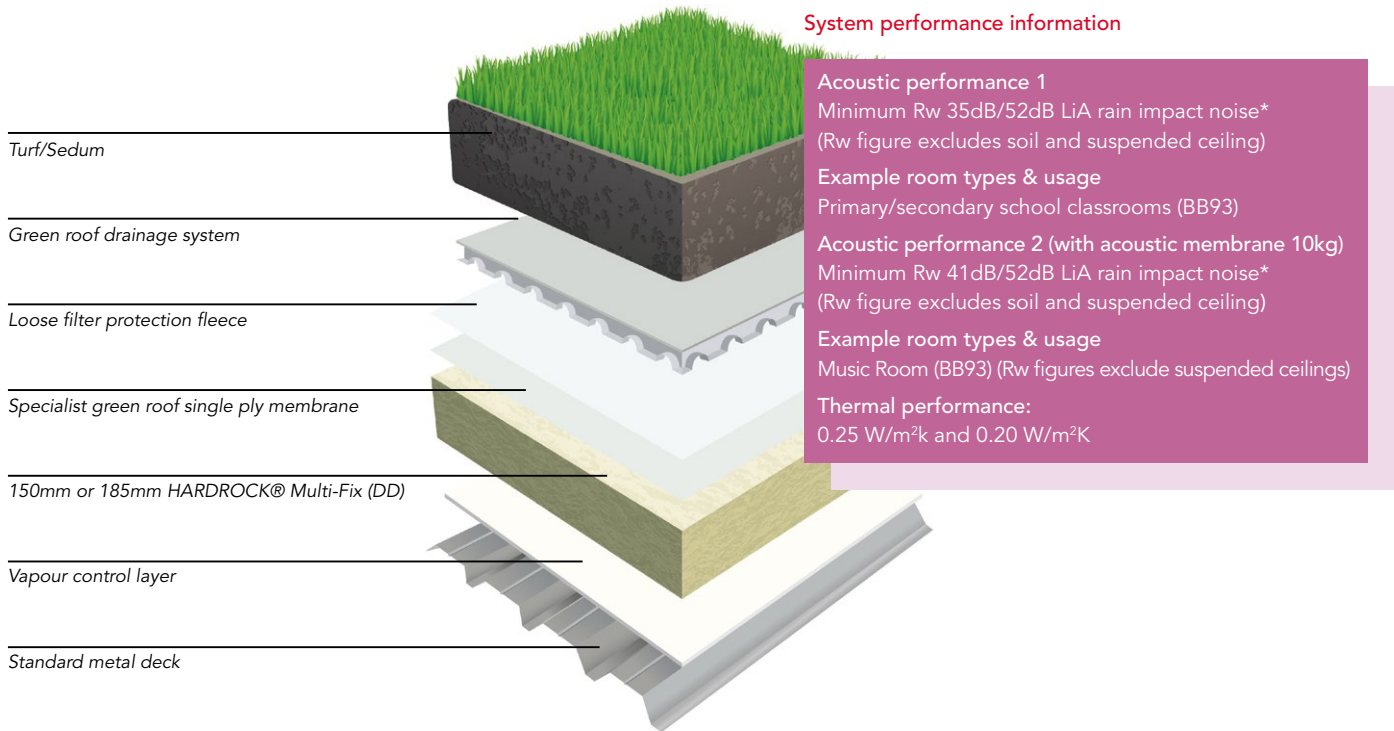

Single ply/EPDM roofing - Fixing options

Mechanically fastened single ply/EPDM membrane systems

HARDROCK® Multi-Fix (DD) roofing boards are suitable for mechanically fastened single ply/EPDM systems.

HARDROCK® Multi-Fix (DD) board fixing method

Where the complete roofing board system is mechanically fastened, it is recommended that a minimum of one mechanical fastener is used centrally per board to secure the boards during installation. The HARDROCK® Multi-Fix roofing boards are to be laid staggered, tightly butt-jointed and mechanically fastened through the vapour control layer to the deck.

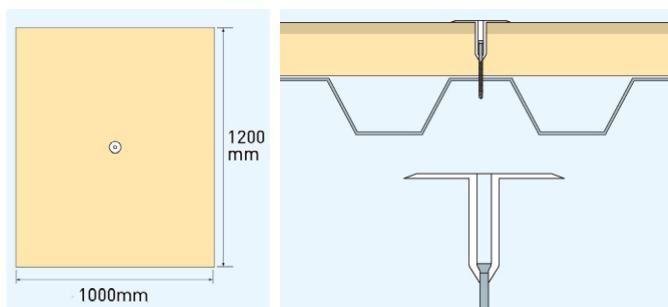

Mechanical fastener type

ROCKWOOL recommend the use of a plastic tube washer, or stress plate support thread when mechanically fastening roofing boards to metal, concrete or timber decks.

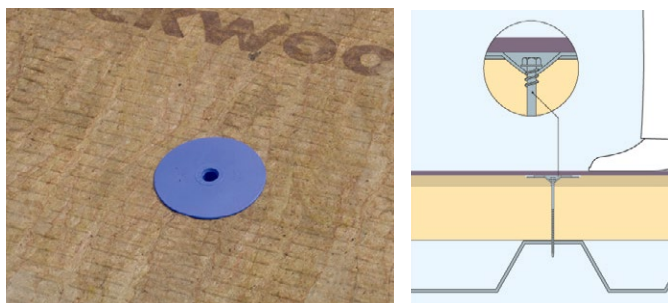

Installed plastic tube and washer

Fully/partially adhered single ply/EPDM membrane systems

HARDROCK® Multi-Fix (DD) roofing boards are to be used with fully or partially adhered single ply/EPDM membranes. The fleece facing of the board encourages a strong bond between membrane and insulation whilst limiting the amount of adhesive needed. A single ply/EPDM membrane which has been tested and deemed compatible for bonding to HARDROCK® Multi-Fix (DD) is to be applied to the insulation with the relevant adhesive.

Where the membrane is fully bonded to the insulation surface, the number of mechanical fasteners per board (if required) should be determined by wind loading calculations conducted by the membrane manufacturer.

HARDROCK® Multi-Fix (DD) installation

The HARDROCK® Multi-Fix (DD) boards are to be laid strictly in accordance with the manufacturer's recommendations, staggered and tightly butt-jointed, and either fully bonded with an approved adhesive or mechanically fastened through the vapour control layer to the deck. The vapour control layer is to be fixed to the deck in accordance with the manufacturer's recommendations.



A bonded membrane incorporating HARDROCK® Multi-Fix (DD) Membrane installation/fasteners

The single ply/EPDM membrane should be installed strictly in accordance with the manufacturer's specification and fastening requirements for wind uplift in accordance with the manufacturer's recommendations.

* Please note: Tests have been conducted, to determine the Rain Generated Impact Sound Transmission of roofing systems in accordance with International Standard ISO 140-18:2006. The LIA results from these tests can be used by acoustic consultants to calculate acoustic conditions to meet the LAeq performance standards. These calculations are complex and consider variables including room volumes, surfaces and finishes, roof / ceiling area, and reverberation data. Test results of various lightweight flat roof constructions with and without the addition of ceiling tiles are available from ROCKWOOL Technical Solutions.

Bitumen/mastic asphalt/green roof - Systems

Example 1 - Single layer system (Mechanically fixed/torched or bonded bitumen)

High performance roofing felt/mastic asphalt

150mm HARDROCK® Multi-Fix (DD)

Foil faced bitumen VCL

Standard metal deck

System performance information

Acoustic performance 1
 Rw 35dB/ 52dB LiA rain impact noise*
 (Rw figure excludes suspended ceilings)

Example room types & usage
 Primary/Secondary school classrooms (BB93)

Acoustic performance 2 (with acoustic membrane 5kg)
 Rw 38dB /52dB LiA rain impact noise*
 (Rw figure excludes suspended ceilings)

Example room types & usage
 Sports Hall (BB93)

Thermal performance
 0.25 W/m²K

Example 2 - Dual layer system (Mechanically fixed/torched or bonded bitumen)

High performance roofing felt/mastic asphalt

60mm HARDROCK® Multi-Fix (DD)

150mm HARDROCK® Multi-Fix base board

Foil faced bitumen VCL

Acoustic membrane 5kg

Standard metal deck

System performance information

Acoustic performance (with acoustic membrane 5kg)
 Rw 41dB (excludes suspended ceilings) 52dB LiA
 impact noise*

Example room types & usage
 Dining Rooms (BB93)

Thermal performance
 0.18 W/m²K

Fire resistance
 120 minutes (integrity & insulation)

Bitumen/mastic asphalt/green roof - Systems

Example 3 - Bitumen green roof system

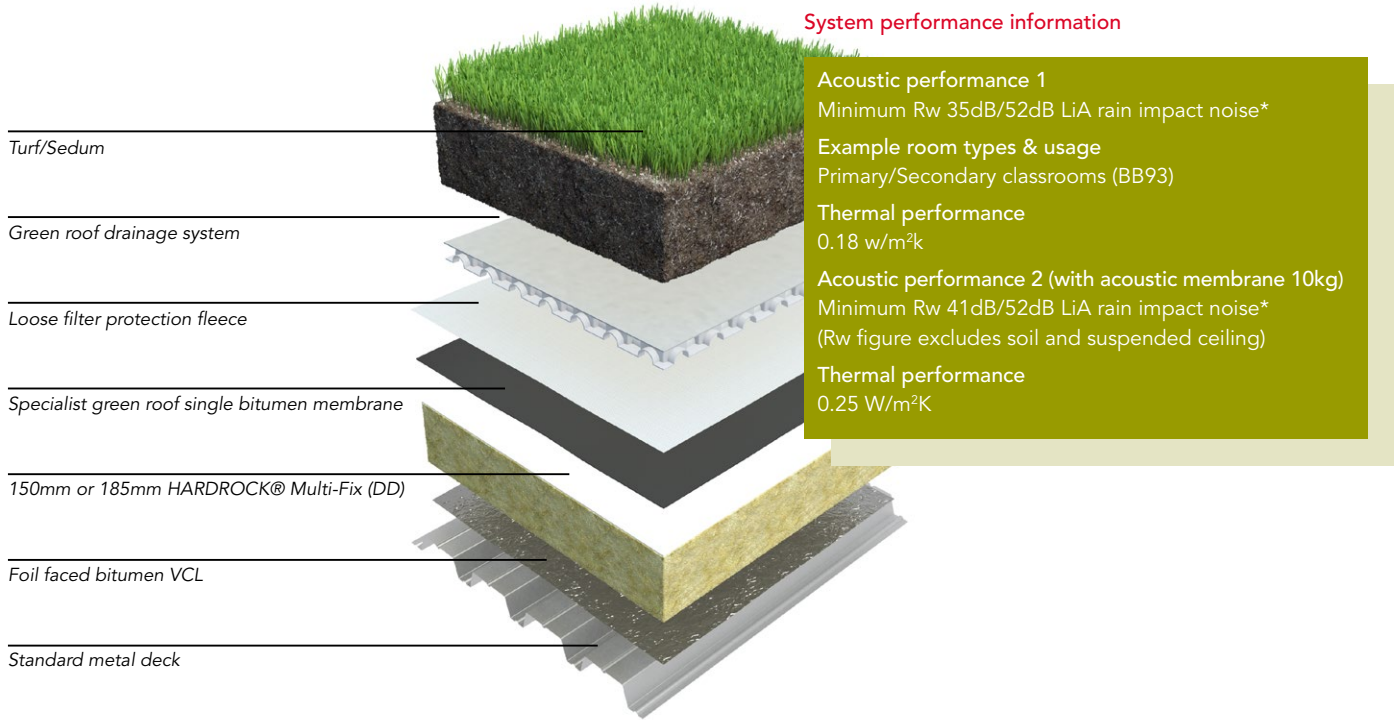

Typical U-values for Metal, Concrete and Timber decks based on standard HARDROCK® Multi-Fix (DD) roofing boards thickness range

U - value (W/m²K)	Metal deck no ceiling	150mm reinforced concrete deck no ceiling	22mm Timber deck no ceiling
0.25	150mm (single layer)	150mm (single layer)	150mm (single layer)
0.22	170mm (single layer)	170mm (single layer)	170mm (single layer)
0.20	185mm (single layer)	185mm (single layer)	185mm (single layer)
0.18	210mm (150*+60mm)	210mm (150*+60mm)	210mm (150*+60mm)
0.16	235mm (150*+85mm)	235mm (150*+85mm)	235mm (150*+85mm)
0.15	255mm (150*+105mm)	255mm (150*+105mm)	255mm (150*+105mm)

* The 150mm product is HARDROCK® Multi-Fix (DD) base board (plain)

HARDROCK® Multi-Fix (DD) solutions

Bitumen/Mastic asphalt/Green roof/Liquid membrane - Fixing options

Built-up high performance bituminous membranes

HARDROCK® Multi-Fix (DD) boards can be used below built-up bitumen roofing (bituminous felt or asphalt).

Roof board installation

For dual layered systems place the 150mm Multi-Fix base board down first and add the fleece faced Multi-Fix top board with the fleece facing upwards to receive the bitumen. For single layer systems, only the fleece faced Multi-Fix top board is required.

The boards are to be laid staggered, tightly buttjointed and either fully bonded in hot/cold bitumen or mechanically fastened through the vapour control layer to the deck.

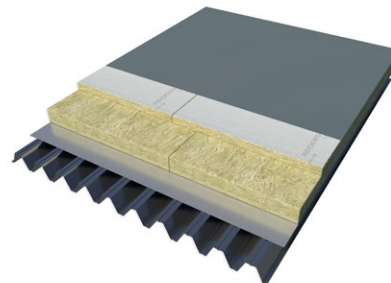

Torch applied bituminous membranes

HARDROCK® Multi-Fix (DD) is designed for use with most fully bonded torch applied multi-layer bituminous systems. When applying the bitumen membrane always torch with minimum heat at all times. Torch the roll of waterproofing felt using appropriate flame/edge guards at all times.

Torch applied bituminous membranes should always be installed in accordance with the membrane manufacturers guidelines.

Liquid applied

Cold liquid applied membranes offer a seamless watertight finish and are ideal for roof refurbishment, roof details and roof repairs. HARDROCK® Multi-Fix (DD) is designed for use with a number of liquid applied membrane systems. For more information, advice and guidance on compatible systems please contact ROCKWOOL Technical Solutions on 0871 222 1780.

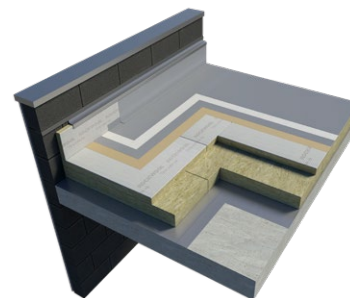

Green roofs

HARDROCK® Multi-Fix (DD) roofing board is suitable for use in green roof constructions. Where an approved mechanically fixed membrane is being used, HARDROCK® Multi-Fix (DD) boards should be laid in accordance with the roof board installation method described opposite.

Where a fully bonded membrane system is used, the approved membrane is fully bonded with approved adhesive to HARDROCK® Multi-Fix (DD) boards. The Multi-Fix boards can be fully bonded or mechanically fastened through the vapour control layer to the deck.

Membranes

For Green roof constructions specialist single ply or bitumen waterproof membranes should be used in accordance with the membrane manufacturer's recommendations.

The fleece, filtration layer and growing matter should be installed over the membrane in accordance with the client's requirements.

Advice on particular green roof schemes and systems should be sought from ROCKWOOL Technical Solutions.

* Please note: Tests have been conducted, to determine the Rain Generated Impact Sound Transmission of roofing systems in accordance with International Standard ISO 140-18:2006. The LIA results from these tests can be used by acoustic consultants to calculate acoustic conditions to meet the LAeq performance standards. These calculations are complex and consider variables including room volumes, surfaces and finishes, roof / ceiling area, and reverberation data. Test results of various lightweight flat roof constructions with and without the addition of ceiling tiles are available from ROCKWOOL Technical Solutions.

HARDROCK® Multi-Fix (DD) Tapered Roofing System

The HARDROCK® Multi-Fix (DD) Tapered Roofing range is engineered to meet the demand for tapered solutions for existing and new flat roof constructions.

The system reduces risk of ponding and standing water and is backed by a complete design to delivery service. Tapered HARDROCK® Multi-Fix (DD) Roofing Boards are manufactured 1200x1000mm and can be fully bonded to the vapour control layer with hot bitumen or adhesive or mechanically fastened through the vapour control layer to the deck.

Thermal performance – U-values

It is a Building Regulation requirement that a tapered roof must be calculated to include all areas of the roof including gutters etc. The roof must be proven to meet the required effective or minimum U-value. Unlike other elements such as walls, floors and non-tapered elements you cannot take a single point U-value.

BRE 443 (conventions for U-values) requires tapered insulation to be calculated as set out in accordance with Annex C of BS EN ISO 6946. A thermal calculation analysis is available on request.

Fixing and marking of boards

Tapered boards are delivered to site individually marked with a positional code corresponding to the detailed layout drawing provided. The board layout should strictly follow that shown on the drawing, and to avoid error it is advisable to place each board in position temporarily prior to attachment.

Standards and approvals

HARDROCK® Multi-Fix (DD) Tapered Roofing Boards have CE marking in accordance with BS EN 13162: 2012, 'Thermal Insulation products for buildings – factory made mineral wool (MW) products specification.'

The HARDROCK Multi-Fix (DD) Tapered Roofing Service

- Site surveys and quotations
- Preparation of bespoke and considered design solutions to any flat roof
- Roof layout drawings required for quotation
- Thermal calculations provided with each project
- Precision manufacture and supply to order
- Site advisory service prior to and during installation
- Reduces risk of ponding
- Rain noise solutions



For support, advice and design assistance with your projects please contact ROCKWOOL Technical Solutions on 01656 868 490 or email technical.solutions@rockwool.co.uk

* Please note: Tests have been conducted, to determine the Rain Generated Impact Sound Transmission of roofing systems in accordance with International Standard ISO 140-18:2006. The LIA results from these tests can be used by acoustic consultants to calculate acoustic conditions to meet the LAeq performance standards. These calculations are complex and consider variables including room volumes, surfaces and finishes, roof / ceiling area, and reverberation data. Test results of various lightweight flat roof constructions with and without the addition of ceiling tiles are available from ROCKWOOL Technical Solutions.

HARDROCK® Multi-Fix (DD) Acoustic System Ancillaries

ROCKWOOL Acoustic Infills

The ROCKWOOL Acoustic Infill consists of trapezoidal shaped ROCKWOOL insulation, which is engineered to suit specified perforated metal roof decking.

The combination of optimised density, fibre direction and excellent fit provides a significant improvement in sound absorption when used together with HARDROCK® Multi-Fix (DD) Roofing Boards on perforated metal roof decking constructions.

Features

- Excellent acoustic absorption - Class C sound absorption performance
- Pre-cut to suit specific roof deck types for fast installation. Available in 1000mm lengths
- Non-combustible
- Facing options for enhanced aesthetic appearance - black/white tissue, melinex or plain

Typical applications

Flat roof areas over convention and sports halls, manufacturing plants, entrance halls, corridors, hallways and stairwells.

Method A as determined by E3 and E4 of Approved Document E can generally be satisfied by the use of ceilings with Class C sound absorption.

See also Building Bulletin 93 (The Acoustic Design of Schools) for guidance.

Installation

Apply the ROCKWOOL Acoustic Infill strips directly within the troughs of the metal deck. Ensure that all joints are tightly butted together. Where lengths of ROCKWOOL Acoustic Infill require to be cut, this is easily facilitated with a sharp knife.

Acoustic solutions and applications

Roof construction:

Mechanically fastened single ply membrane system:

1. D60 perforated steel deck 13% open area
2. ROCKWOOL Acoustic Infill D60
3. Polythene vapour control layer (VCL), 0.22mm
4. HARDROCK® Multi-Fix (DD) dual layer system totalling 210mm (105+105mm)
5. Mechanically fastened single ply membrane system.

Results

Weighted Sound Absorption Coefficient = $W = 0.6(LM)$

Noise Reduction Coefficient NRC = 0.90

Absorption Classification = Class C

Weighted Sound Reduction Index = $R_w = 39dB$

Test Report: C/06/5L3434/2.

Frequency	125	250	500	1K	2K	4K
Sound absorption coefficient	0.55	0.94	1.09	0.95	0.59	0.44

Acoustic performance/solutions

Solution to E3 and E4 of the Approved Document E A perforated metal deck construction including ROCKWOOL Acoustic Infill and HARDROCK® Multi-Fix (DD) roofing boards will achieve Classification C sound absorption rating in accordance with BS EN ISO 11654:1997.

HARDROCK® Multi-Fix (DD) Acoustic System Ancillaries

ROCKWOOL Acoustic Membrane

The control of noise pollution is an ever increasing problem and one that must be addressed at the design stage. The solution needs to be specific to each building and is dependent on the type and source of the noise, both inside and outside the building.

HARDROCK® Multi-Fix (DD) roofing insulation can meet most acoustic requirements without the need for an additional membrane layer. Where very high acoustic specifications are required, Acoustic Membrane offers the additional mass needed.

ROCKWOOL Acoustic Membrane is a high performance, sound deadening flexible polymer mass layer for enhancing ROCKWOOL Multi-Fix (DD) acoustic roofing systems. Typical building types requiring acoustic roof solutions include: schools, hospitals, cinemas, airports, concert halls, stadia, retail and leisure developments.

Installation

ROCKWOOL Acoustic Membrane should be laid directly onto the metal decking, across the line of the profiles. The metal decking must be clean and dry.

Align the membrane and extend the roll over the metal decking progressively allowing for a 50mm overlap at all edges.

Please note that it is not necessary to remove the protective plastic film.

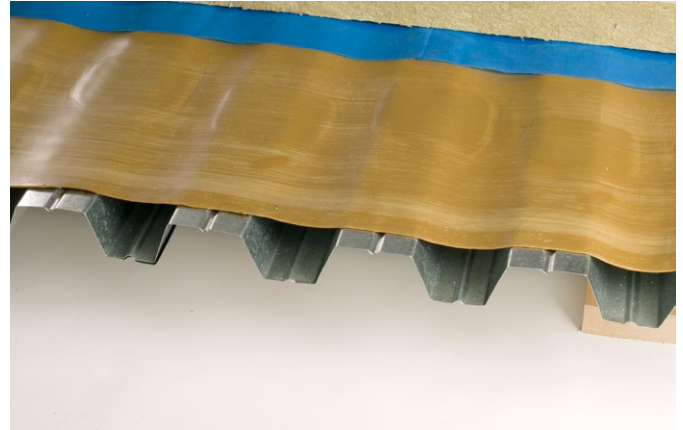

Roof construction

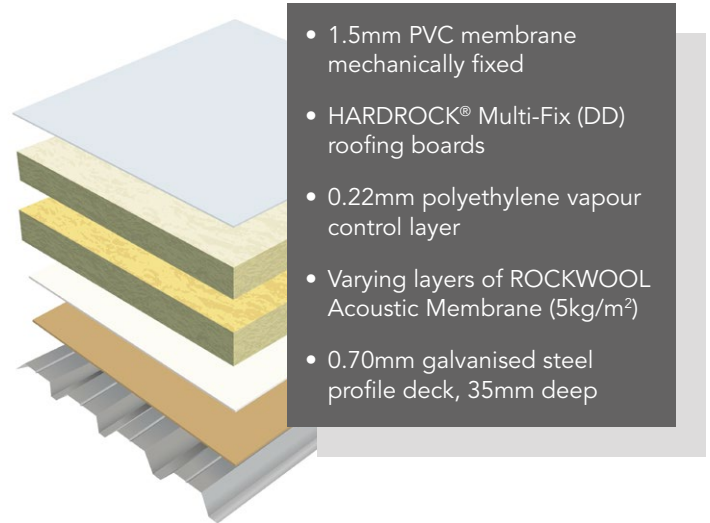

- 1.5mm PVC membrane mechanically fixed
- HARDROCK® Multi-Fix (DD) roofing boards
- 0.22mm polyethylene vapour control layer
- Varying layers of ROCKWOOL Acoustic Membrane (5kg/m²)
- 0.70mm galvanised steel profile deck, 35mm deep

HARDROCK® Multi-Fix (DD) Roofing boards

Design considerations

Flat roof design

The roof construction and design should comply with BS 6229 (Code of Practice for Flat Roofs with Continuous Supported Coverings).

Design considerations for profiled metal decks

Crown and trough position

HARDROCK® Multi-Fix (DD) roofing boards must be laid with the long edge at right angles to the profiles of the metal deck. Butt joints should occur at the midcrown position, except where cantilevering is applicable.

Free spanning capability

For free spanning, the minimum board thickness is equal to the maximum trough width divided by 3. The maximum trough width suitable for free spanning HARDROCK® Multi-Fix (DD) is 300mm.

Where installed trough widths exceed the maximum spanning capability of the board, provision must be made to provide full support for the insulation.

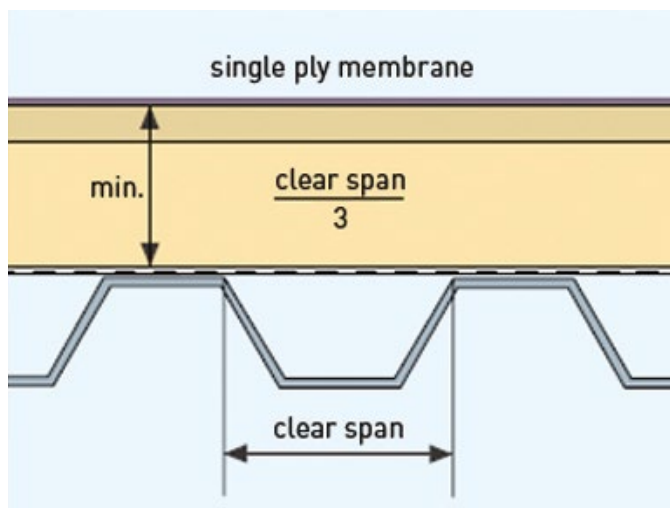

Note that the span to be measured is across the clear width of the trough, and not from the centre to centre of the crowns.

Cantilevering

- Boards of 60mm or greater thickness may Cantilever over a trough
- For cantilevering the minimum board thickness is equal to the maximum trough width divided by 2



Walkways and access areas

It is an industry recommendation that a supporting layer be placed on the roof both during installation and upon completion in designated walkways or in areas of high foot traffic. Advice should be sought from the membrane manufacturer about available options.

Additional roof loads: Plant and machinery

- Wherever possible, any roof-mounted plant, such as air handling or refrigeration units, should be positioned on independent upstands bearing directly onto the substrate
- Where this is not possible, and the equipment is to be placed directly onto the finished roof, further protection may be required to spread the load on the Multi-Fix roofing boards. In such cases advice should be sought from the ROCKWOOL technical solutions team and the membrane manufacturer.

Preparation work for refurbishment works

- Check that the existing roof finish is sound and watertight
- Check that the type and condition of the surface is suitable for bonding or mechanical fixing of HARDROCK® Multi-Fix (DD) roofing boards. If the roof is not sound and watertight or does not have a suitable surface, remove all previously applied finishes and if necessary, insulation layers
- It is recommended that the specifier/contractor checks the existing levels to ensure that the falls are sufficient.

HARDROCK® Multi-Fix (DD) Flat roof boards

General overview

Laying and cutting HARDROCK® Multi-Fix (DD)

1. For dual layer systems, the 150mm ROCKWOOL Multi-Fix base board is applied first, onto the Vapour control layer. The Multi-Fix fleece top layer is applied to the base board with the fleece facing upwards
2. The HARDROCK Multi-Fix (DD) roofing boards should be laid with staggered joints and tightly butted to avoid gaps
3. Ensure that the fleece layer is used on the upper side towards the membrane. This is clearly marked on the boards as 'ROCKWOOL® - this side up'
4. The boards are easy to cut to shape using a fine toothed saw or panel saw
5. Care should be taken to clean off all surfaces prior to the laying of the boards and membrane
6. Appropriate stop battens should be installed to protect the boards' open edges during installation
7. Day joints must be formed at the conclusion of each section of work to seal exposed edges and prevent damage.

Protection of HARDROCK® Multi-Fix (DD) roofing board during installation

Adequate temporary protection must be provided above the installed boards where any of the following occur:

- Unloading or access points
- Temporary walkways
- Stockpiles of roofing materials
- Waste skips
- Any other activity that might cause damage to the insulation.

Working platform

Under no circumstances should the finished roof be used as a working platform without adequate protection being provided.

ROCKWOOL recommends that either the main or roofing contractor operates a 'permit to work' system for any follow-on trades in areas where the roof installation is carried out.

Handling and storage

ROCKWOOL HARDROCK® Multi-Fix (DD) roofing boards are fully palletised and wrapped in a polythene shroud for protection during transit and for short-term protection if stored outside.

For longer-term protection, the pallets should be stored under a secure waterproof covering. Boards should be stacked no more than two pallets high for safety.

The use of a pallet fork is recommended where a crane is required to lift pallets to roof level.

ROCKWOOL Rock Roller trolley

To facilitate fast and easy movement of HARDROCK® Multi-Fix (DD) roofing boards from the loading area to the point of installation on the roof deck, ROCKWOOL has developed a purpose made 'trolley'. Each Rock Roller comes complete with operating instructions, which should be followed by the roofing contractor.



Notes

Notes

September 2018

ROCKWOOL Limited

Pencoed
Bridgend
CF35 6NY

Tel: 01656 862 621
info@rockwool.co.uk
rockwool.co.uk

