

Double Roman
Code: GTV-DR

For use with:

Marley Double Roman
Redland Double Roman
Sandtoft Double Roman
Russell Double Roman
Lagan Double Roll

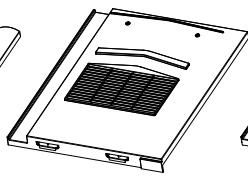

Non-Profile
Code: GTV-NP

For use with:

Marley Modern
Redland Mini Stonewold
Sandtoft Calderdale*
Russell Grampian
Lagan Flat

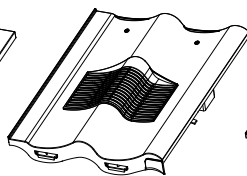

Double Pantile
Code: GTV-DP

For use with:

Marley Mendip
Redland Grovebury
Sandtoft Double Pantile
Russell Pennine

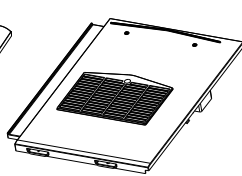

Thin Leading Edge
Code: GTV-TE

For use with:

Marley Edgemere
Redland Richmond
Sandtoft TLE
Russell Galloway
Lagan Elite

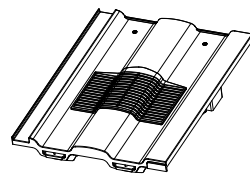

Castellated
Code: GTV-CS

For use with:

Marley Ludlow Major
Redland Renown
Sandtoft Lindum
Russell Cheviot
Lagan Square Top

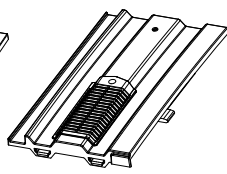

Mini Castellated
Code: GTV-MC

For use with:

Marley Ludlow Plus
Redland 49
Sandtoft Standard attern
Forticrete V2

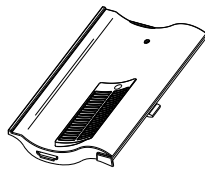

Single Pantile
Code: GTV-SP

For use with:

Marley Anglia
Redland Fenland
Sandtoft Shire

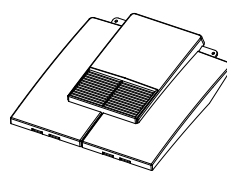

Plain Tile
Code: GTV-PT

For use with:

Concrete and traditional
clay plain tiles.
Granulated finish vents
are also available.

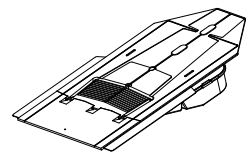

Slate Vent (In-Line)
Code: GILSV30-25

For use with:

Man-made and
natural slates.
600 x 300mm
in size.

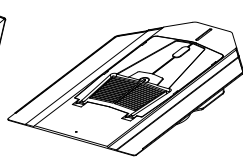

Slate Vent (In-Line)
Code: GILSV25-20

For use with:

Man-made and
natural slates.
400 x 200mm up to
500 x 250mm.

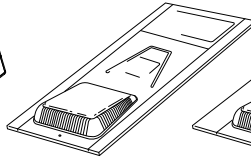

Slate Vent (Hooded)
Code: GRSV30-25

For use with:

Man-made and
natural slates.
500 x 250mm up to
600 x 300mm.

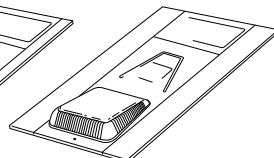

Slate Vent (Hooded)
Code: GRSV45

For use with:

Man-made and
natural slates.
500 x 250mm up to
600 x 450mm.

*Non-Profile vent will suit the original Calderdale tile, for the Calderdale Edge tile use the Flat Edge tile vent.

Manthorpe Building Products Limited

Manthorpe House, Brittain Drive, Codnor Gate Business Park, Ripley, Derbyshire DE5 3ND
T: (01773) 514200 F: (01773) 514262 E: bpsales@manthorpe.co.uk
W: www.manthorpe.co.uk



Interlocking Plain Tile Ventilator

Fitting Instructions

MBP1105b

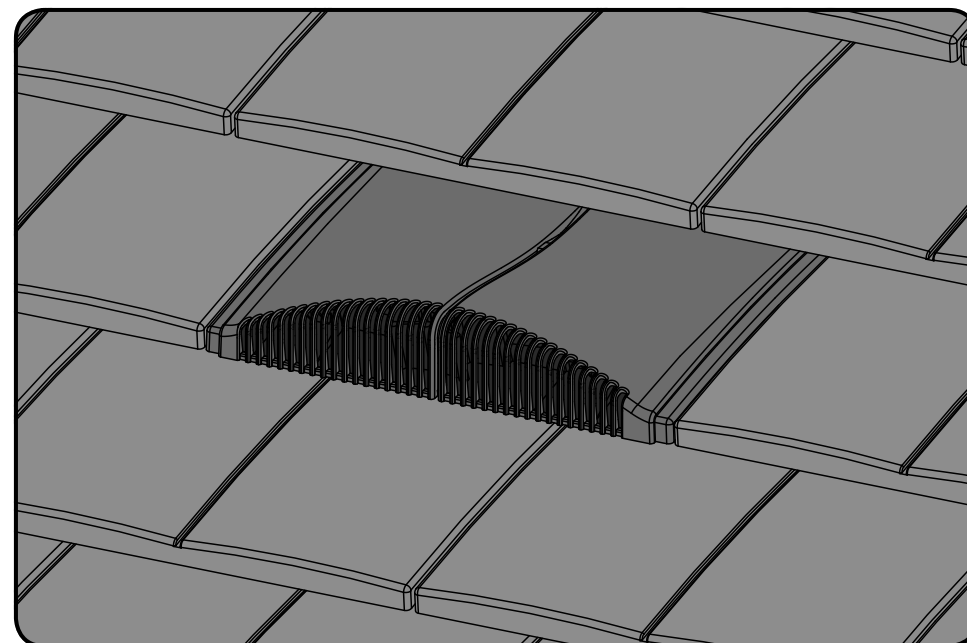

Interlocking Plain Tile Ventilator Installation Requirements:

- **Minimum Roof Pitch:** 22.5° DO NOT INSTALL BELOW THIS PITCH
- **Maximum Headlap:** 95 mm
- **Product Airflow:** 6,000 mm²

The tile vent should not be used to extract hot exhaust gases, nor be placed close to other potentially hot elements of the roof structure.

When ventilating at high level, the vent should not be placed on the course directly below the ridge tile.

For mechanical extraction, use the Manthorpe **GTV-AD Flexi Pipe Adaptor** and one of the **GRPA Flexible Pipe Range** in conjunction with the vent.

Required roofspace ventilation:	5,000mm ² /M	10,000mm ² /M	25,000mm ² /M
Install one tile ventilator every:	1200mm	600mm	240mm

Installation

1. Prepare the roof tiles in the conventional manner, tiling up to the point at which you require the tile ventilator to be positioned.

NOTE: The vent cannot be placed directly over a rafter.

2. Directly below the batten that the vent is to be placed on, mark out a rectangle 60mm x 260mm wide on the underlay in line with the centre of where the vent will sit. Also mark an X in the centre of this rectangle from corner to corner.

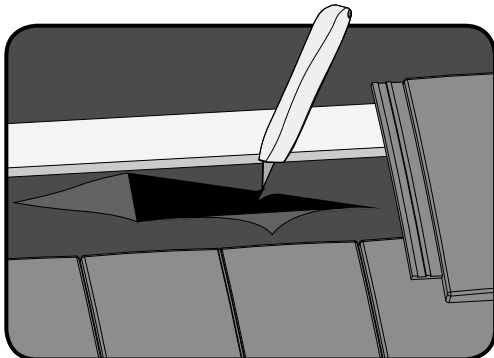
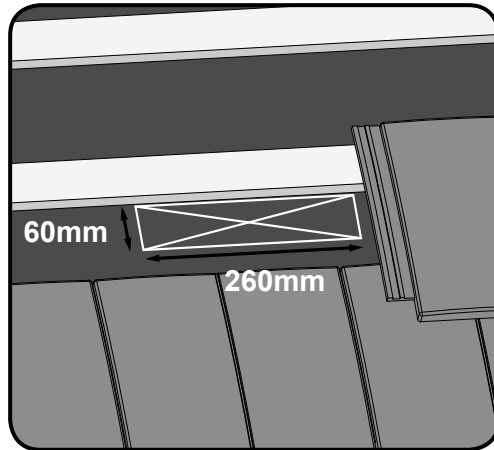

3. Cut the underlay along the diagonal X lines and fold back the triangular tabs to reveal the spigot opening.



4. Fold the top tab tight up against the batten above it and secure it in position with a staple or tack.

The ventilator can be used in conjunction with all 3 styles of interlocking plain tile; the **Redland DuoPlain**, **Marley Ashmore** and **Forticrete Gemini**. See step 5 for details on aligning the vent for use with your chosen profile.

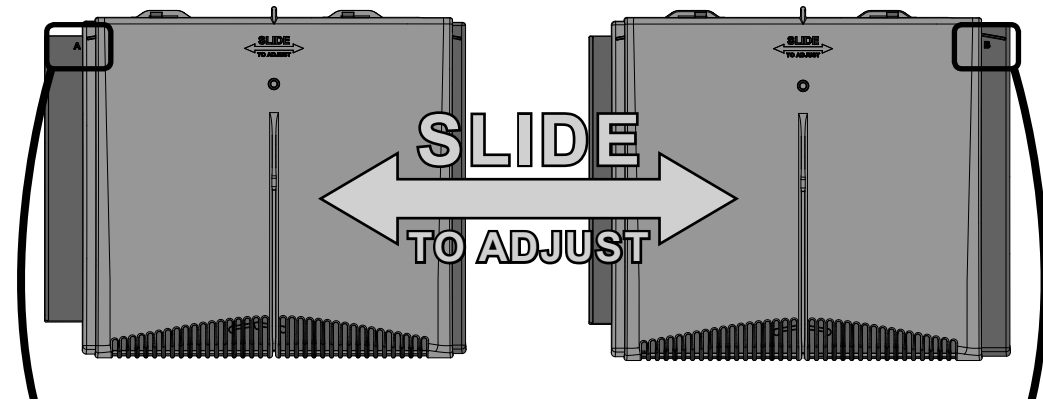

Position A for use with DuoPlain & Ashmore

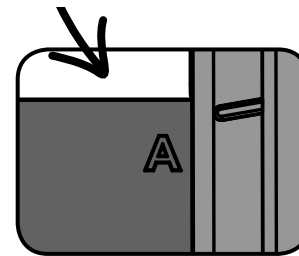

5. After identifying the correct position for your style of tile, hold the vent by the interlock and slide the upper surface to the left or right using the top tab to uncover the designated letter for your profile. Slide right for position A, slide left for position B.

Position B for use with the Forticrete Gemini

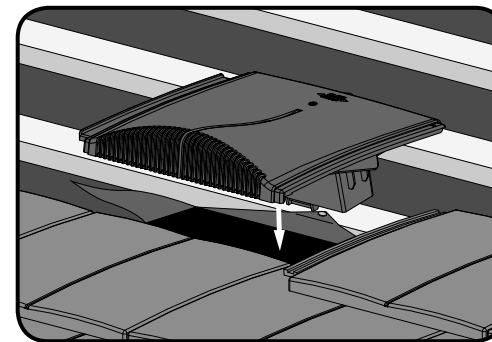
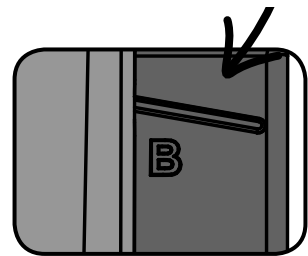

6. Insert the vent into the correct position on the roof, making sure the spigot passes fully through the felt so it is accessible from the loftspace. Ensure that the tile vent sits square and securely over the interlock of the adjacent tile.

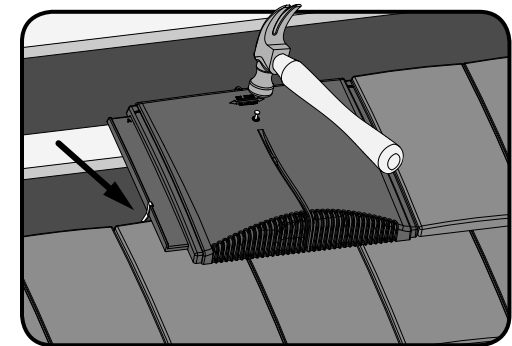

7. Nail the vent down into position by perforating the skin over the pre-formed hole. Clip the vent in place using the tile manufacturers specified clips for the relevant tile. Once fixed, continue tiling in the normal manner.