

Installation Guidelines



The following instructions are just a guide, and standard roofing procedures should be applied. Installers should follow guidance given in BS5534 – construction of pitched roofs (section 4), BS 5250 moisture management and ventilation and BS 8000-6 workmanship. Eco Slate is impermeable to water so requires the installation of a suitable external membrane over the sarking board.

Installers must use suitable external vapour open weatherproof membrane, we also recommend an air barrier on the warm side of the insulation for cold roof applications or an air and vapour control barrier membrane to the warm side of the insulation for warm roof applications. Please check membrane manufacturer literature to ensure the correct membranes are used.

Eco Slates do not absorb water which means that water penetration is non-existent from the roof surface itself. However, the use of vapour/air barriers minimise the risk of moisture accumulating on the underside of the slates/OSB as the most common source of moisture is generated inside the property itself.

The OSB sheeting should be a minimum 18mm thickness.

Before you start...

The Roof Base needs to be 18mm ply or OSB board with a suitable breather membrane on the top surface with the correct **vented** space below the boards/sarking. This is essential to avoid structural damage to the boards supporting the Eco Slate layer.

Prepare the roof base ensuring that the area is free from debris, dirt and sharp edges.

Nails: stainless steel or hot galvanised, 15mm with a head of 5mm minimum.

Tools: hammer, chalk line, Stanley knife / snips.

Storage: keep in a warm environment in winter months as slates become rigid in colder weather.

Ventilation

BS 5250 stipulates guidelines with regards roofing ventilation and condensation. Its primary concern is to eradicate condensation, which is mainly generated from within the home, from reaching and destroying the roof structure timber. Even when timber is not used in the roof construction, the vapour still needs to be properly extracted to prevent it from affecting other parts of the building.

Eco Slate is classified as an "Insufficiently Air Open" product, meaning that water vapour cannot vent to atmosphere directly through the tiles, and so provision must be made to ventilate the roof space to move water vapour from inside to outside. Proper ventilation is an essential part of modern-day roofing.

BS 5250 requires all roof structures to be ventilated at both low-level (air moving into the roof), which is typically at the eaves, fascia or soffit and at high-level (air moving out of the roof), which is typically at the ridge/hip, abutment, or with the use of fixed ventilation units.

Obstructions such as dormers, valleys, roof windows, compartment walls, fire barriers and changes in pitch create separate voids below the roof slope. Ventilation openings should be provided to each void at high and low level.



Completely remove all other roofing materials before installing Eco Slate.



Do NOT lay on or use bitumen-based felt or other bitumen-based products.



Do NOT use a nail gun to install Eco Slate.

1. Lay the first row

Lay the first **double row** of slates as a starter row using an eaves tray to ensure a minimum fully supported overhang of 20mm, or half of gutter width.

Overhang should be supported with bull nose or plain edge trims/eaves tray to prevent sagging in warm weather!

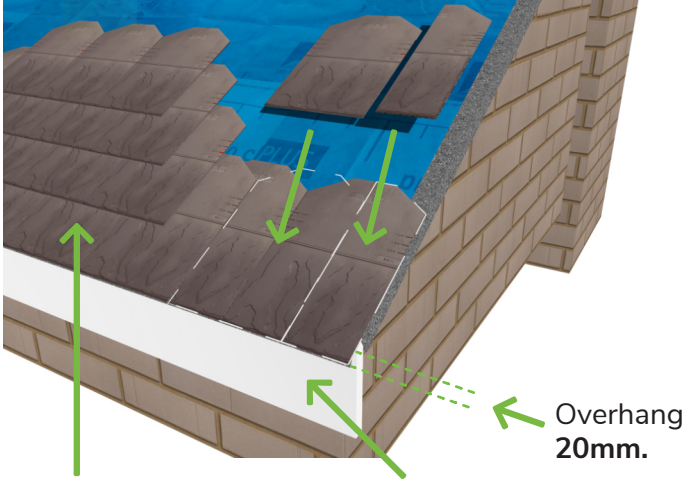

Begin second row with a right-hand **half slate**.

Begin with a **double row** the second directly on top of the first, staggered so the top **overlaps the gap** below.

2. Align & overlap



Each slate has embossed guidelines to aid location; the **vertical lines** at the top of the slate assist in locating slates horizontally.

Horizontal lines on the edges are a guide for the overlap required dependant on pitch.

Roof pitch	Lap Guide
10 – 14 degrees	Align to 160 lap guide line
15 – 20 degrees	Align to 180 lap guide line
21 – 45 degrees	Align to 200 lap guide line

Lap guide

Allow sufficient overlap to accommodate for expansion and contraction.

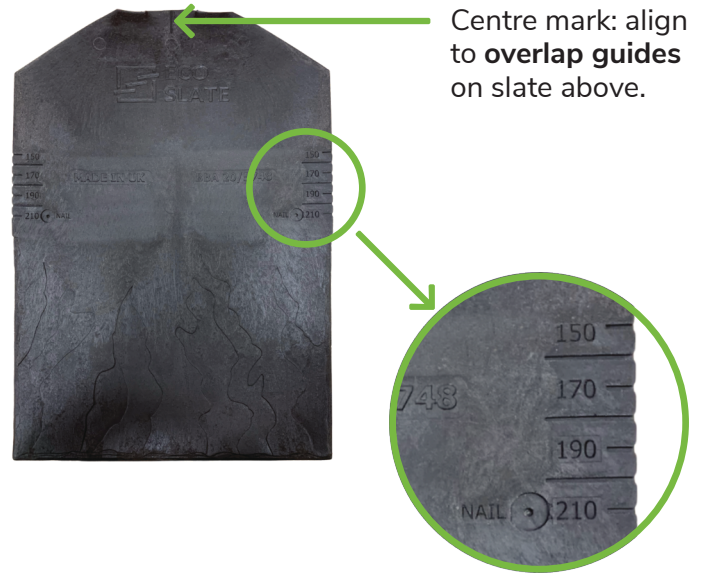

Centre mark: align to **overlap guides** on slate above.

The slates have **overlap marks** with 150, 170, 190 & 210mm graduations marked. The 3 longer intervening lines mark overlaps of 160mm, 180mm & 200mm - see below.

NOTE: the lower the pitch the greater the overlap - see illustrations below.

10-14 degree roof pitch

22 slates per square metre.

160mm guide (longer line) determines size of overlap align to top of slate below.

Align with **centre mark** on slate below.

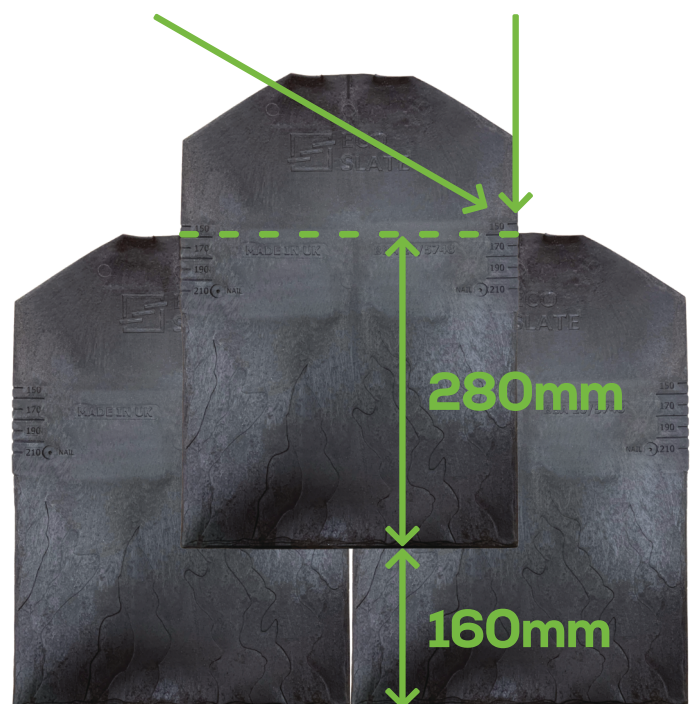

15-20 degree roof pitch

19 slates per square metre.

180mm guide (longer line) determines size of overlap align to top of slate below.

Align with **centre mark** on slate below.

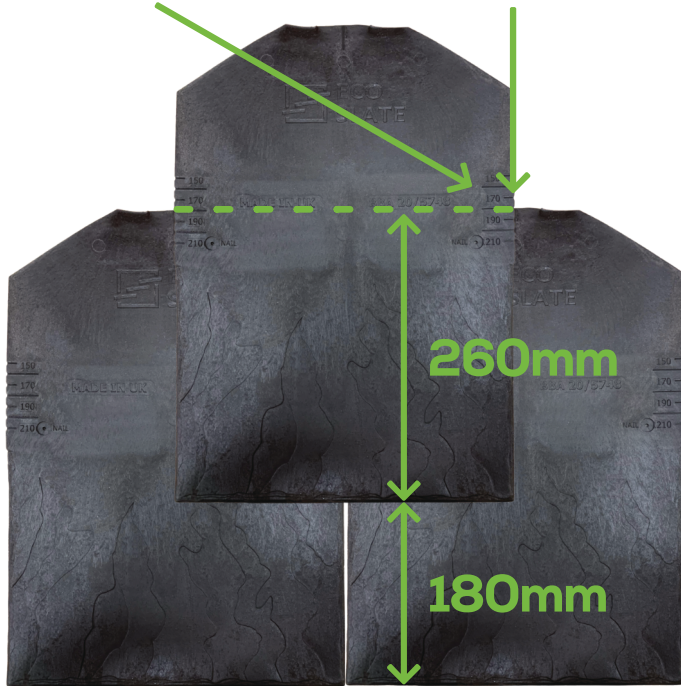

20-45 degree roof pitch

17 slates per square metre.

200mm guide (longer line) determines size of overlap align to top of slate below.

Align with **centre mark** on slate below.

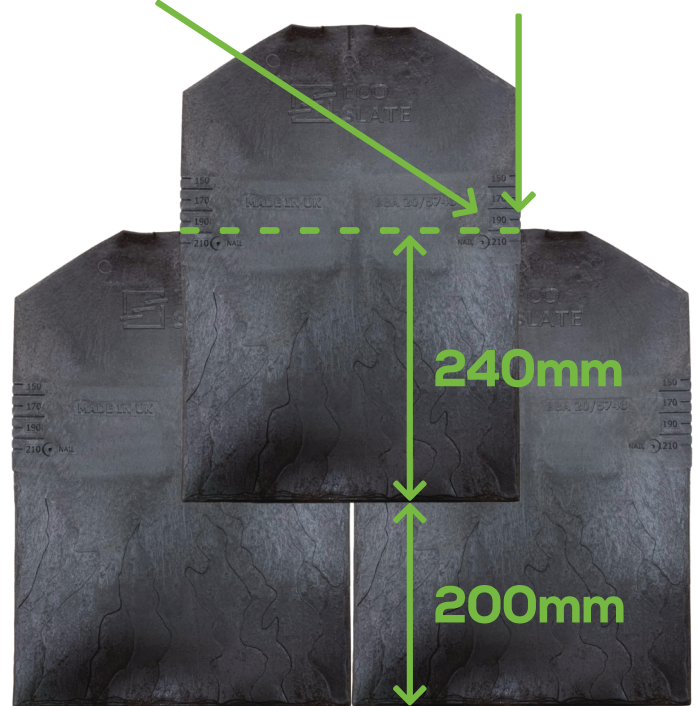

Installation pattern for all pitches

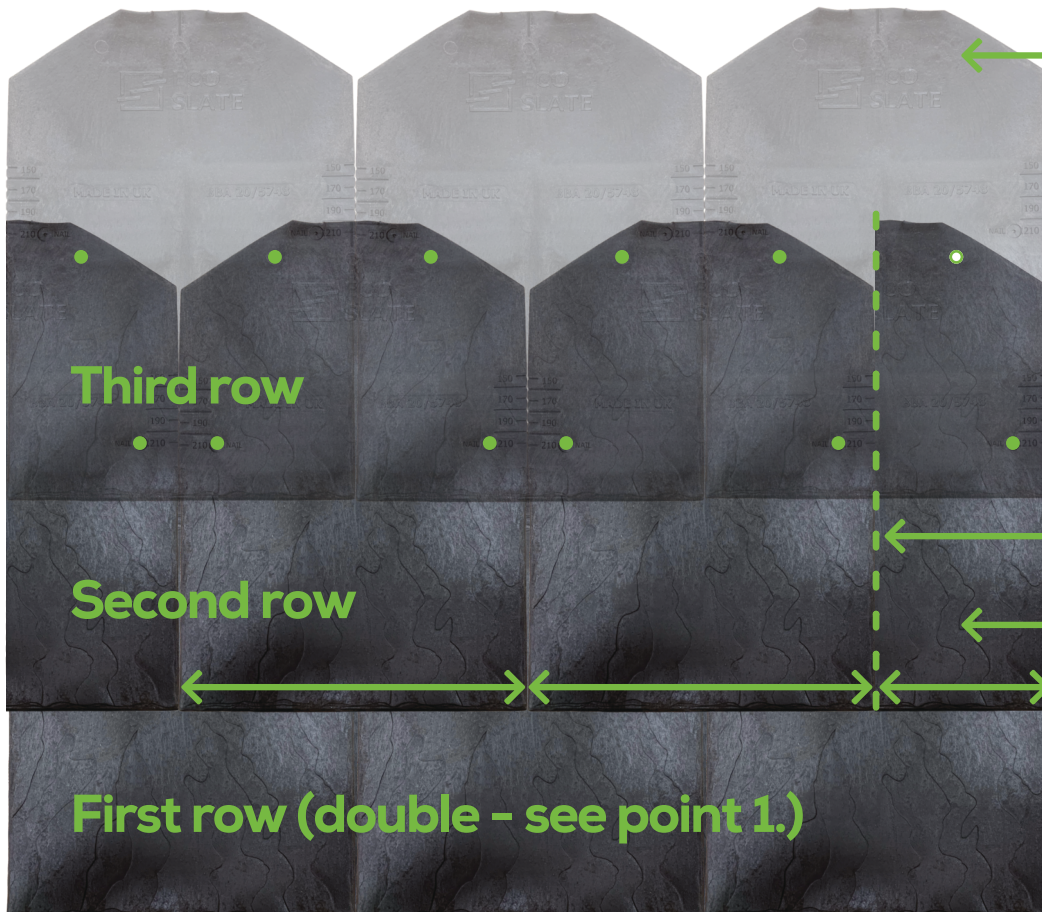

The next row of slates covering joints in layer underneath.

- nail as marked
- extra nail when covering half slate below only

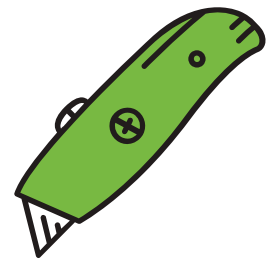

To **stagger joints** begin row with half slate, use other half to begin the next row at opposite end.

3. Hips & ridges

Eco Slate is flexible and can be used for ridges and hips as described below. Alternatively, Eco Slate can be used with conventional ridges and hips.

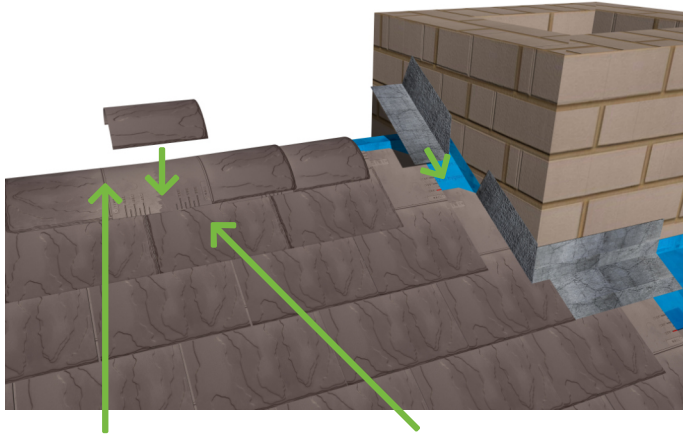

Begin the ridge slates by starting part way along the ridge so both ends can end with the slate facing the correct way.

Cut half slates along the width to finish at the ridge batten.

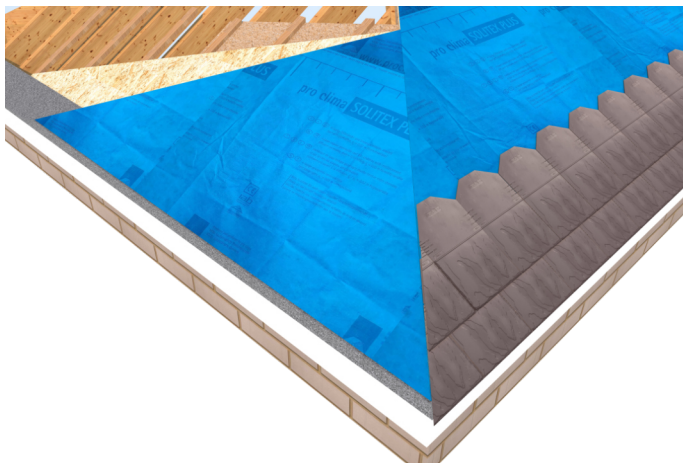

This sequence of images show how to lay the slates either side of the hip in a roof, building up the rows on each slope and cutting the slates at the hip angle required.

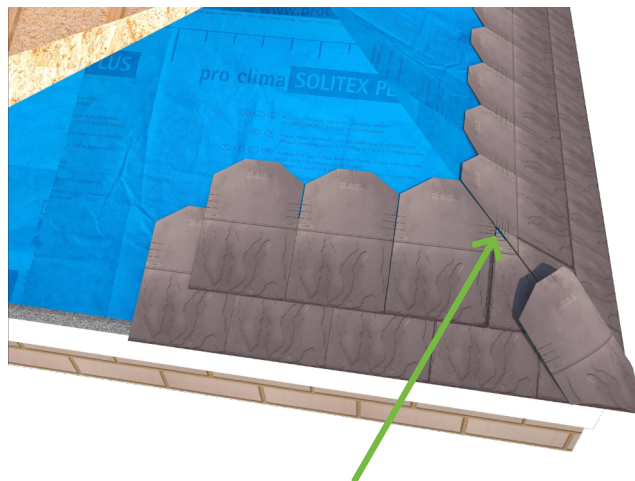

Once the rows on each slope have begun, the hip ridge slates can be fitted over the gap between the rows, forming a ridge-like detail up the hip.

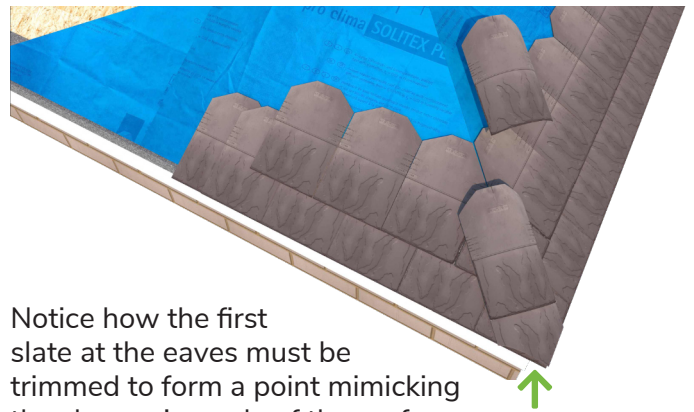

Notice how the first slate at the eaves must be trimmed to form a point mimicking the change in angle of the roof form / line of eaves.

4. Edges

Verges

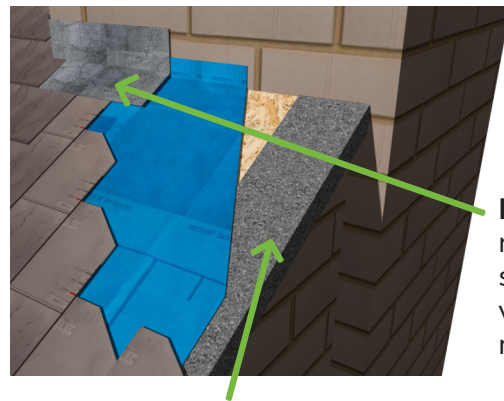

Flashing running down sarking at the verge, breather membrane...

Verge trim must be installed with an overhang of 20mm. The roof membrane should be taped to the verger trim using a suitable weatherproof tape leaving 50% of the trim exposed to the underside of the edge slates.

Eaves

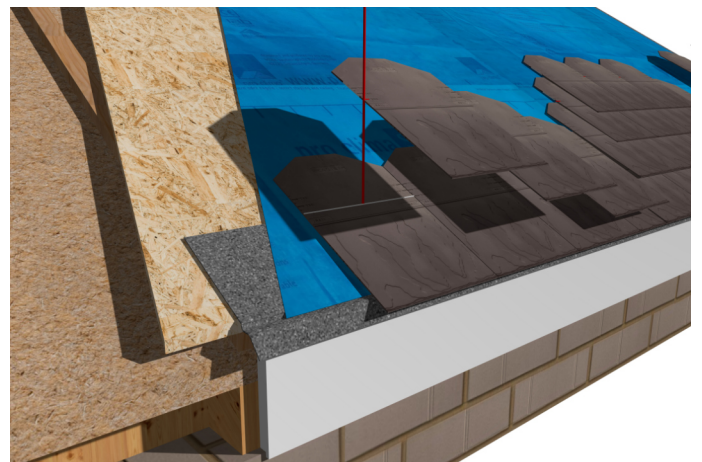

This image shows the build up of fascia, OSB sarking board, plastic eaves tray, the membrane should be taped to the eaves tray using a suitable weatherproof tape leaving at least 50% of the eaves tray exposed then the first two equal courses of slates which must overhang by 20mm.

5. Flashings

Verge to wall & chimney

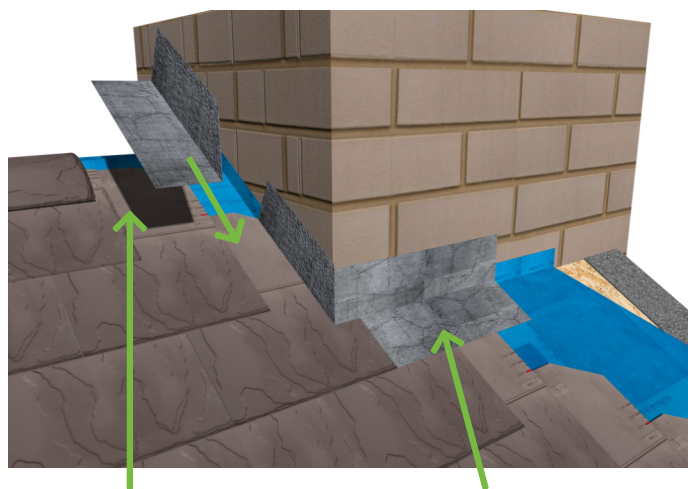

This image shows how **lead soakers** sit underneath each final slate on a row as it reaches a wall or chimney stack.

You can also see how the **soaker** returns around the bottom of the stack under the row that coincides with the wall / stack junction.

Pipes & penetrations

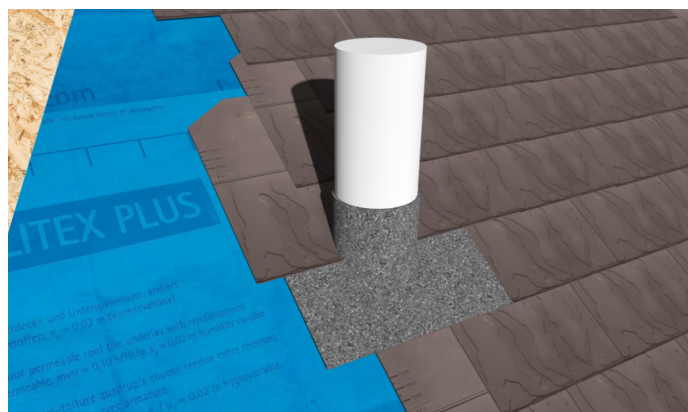

This image shows how **penetrations** such as flues or vent pipes are flashed into the roof build up and slates just the same as you would with conventional slates. The flue will have a flashing kit which is fitted in sequence with the slate rows.

Tips

In cold weather store the Eco Slates inside before use to keep pliable

Slates can be mechanically bonded using a heat gun - please ask for advice on how

Always mix (randomise) up boxes and slates before use

Skylights

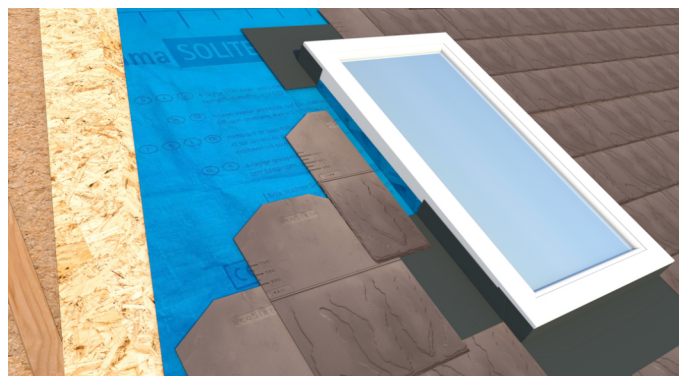

This image shows how **skylights** are flashed into the roof build up and slates just the same as you would with conventional slates. The skylight will have a flashing kit which is fitted in sequence with the slate rows.

Glossary

Hip: where two pitched roofs meet

Ridge: the horizontal junction between two roof slopes

Eaves: the edges of the roof which overhang the face of a wall

Verge: the edge of a pitched roof as it meets the gable end

Sarking: a rigid board fixed over the rafters before the addition of roof membrane or slates

Eaves trim: a plastic or metal strip for supporting and weatherproofing the roof edge to protect the roof and support slates at the eaves

Verge trim: a plastic or metal strip for supporting and weatherproofing the roof edge to protect the roof and support slates at the verges

Dry ridge/hip: a proprietary system of membrane, flashing and brackets designed to allow weather protected ventilation at the ridge or hip on a roof usually supplied in kit form

Ecoroofing Systems Ltd.

📞 01323 356 006

✉ office@ecoroofingsystems.co.uk

🌐 ecoroofingsystems.co.uk